

STRUCTURAL CALCULATIONS

MERCER RESIDENCE

6950 SE Maker Street
Mercer Island, WA 98040

CODE: IBC 2018 & ASCE/SEI 7-16
PROJECT NO.: 22-300

D. S. Engineering
Consulting Structural Engineers

3121 147th Place SE
Mill Creek, WA 98012
T: 425-338-4776

06/22/2022

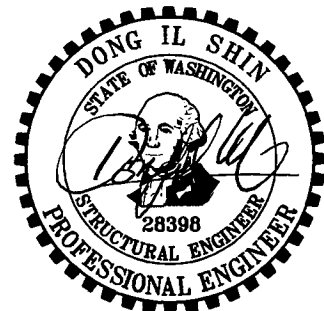

00339

Design Analysis

ROOF:

DL: 25 PSF (INCLUDED 10 PSF SOLAR)

LY: 20 PSF

SL: 25 PSF

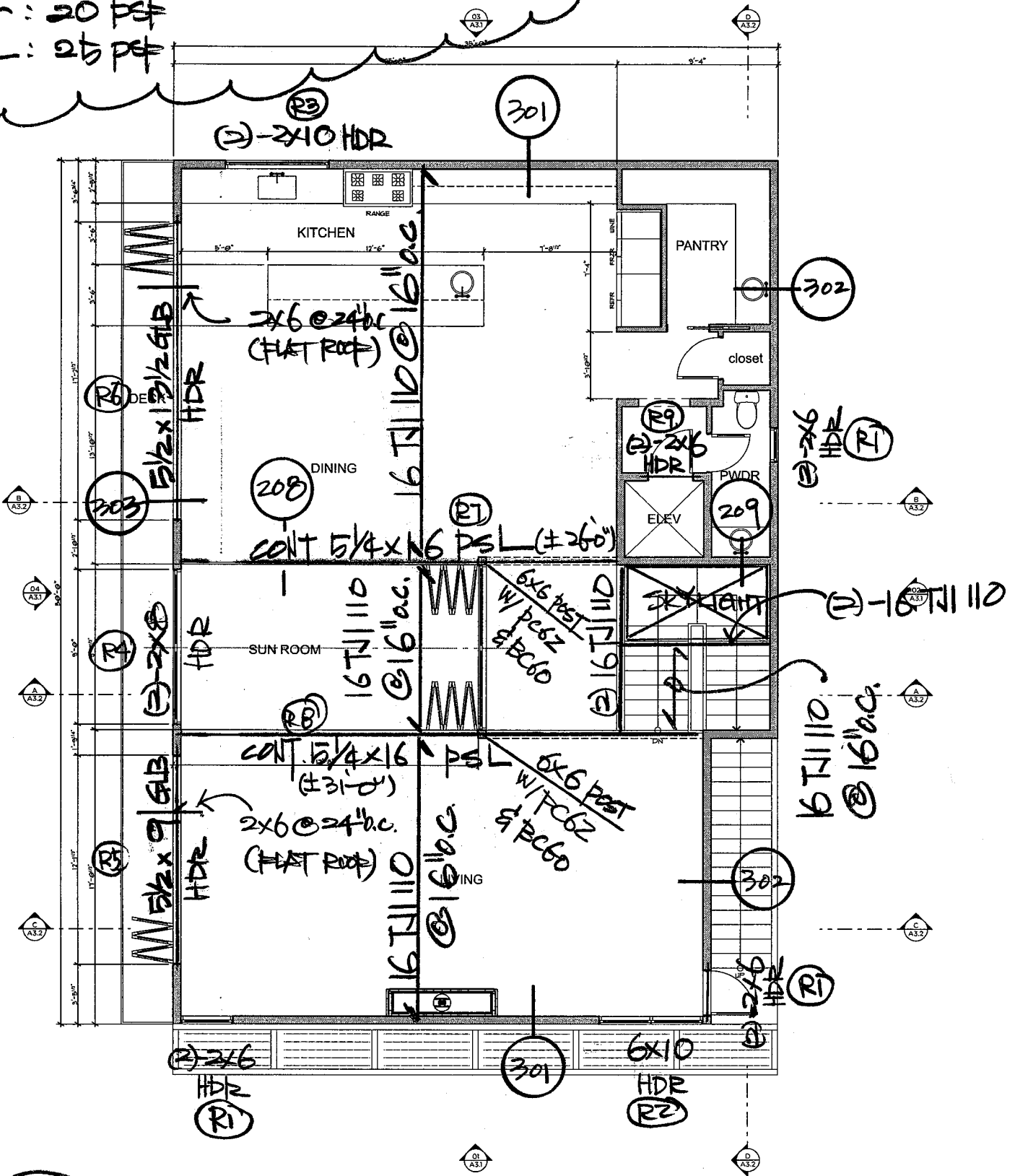

SECOND FLOOR PLAN

SCALE: 1/4" = 1'-0"

DECK

DL: 20 PSF

LL: 60 PSF

SL: 25 PSF

ROOF FRAMING PLAN

Level, Roof: Joist
1 piece(s) 16" TJI@ 110 @ 16" OC

Overall Length: 23' 6"

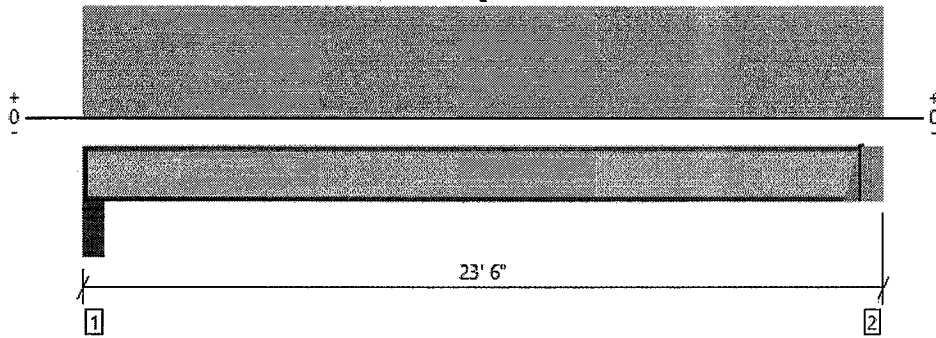

All locations are measured from the outside face of left support (or left cantilever end). All dimensions are horizontal.

Design Results	Actual @ Location	Allowed	Result	LDf	Load: Combination (Pattern)
Member Reaction (lbs)	756 @ 23' 1/2"	1047 (1.75")	Passed (72%)	1.15	1.0 D + 1.0 S (All Spans)
Shear (lbs)	756 @ 23' 1/2"	2467	Passed (31%)	1.15	1.0 D + 1.0 S (All Spans)
Moment (Ft-lbs)	4281 @ 11' 8 1/2"	4922	Passed (87%)	1.15	1.0 D + 1.0 S (All Spans)
Live Load Defl. (in)	0.399 @ 11' 8 1/2"	0.756	Passed (L/682)	--	1.0 D + 1.0 S (All Spans)
Total Load Defl. (in)	0.797 @ 11' 8 1/2"	1.133	Passed (L/341)	--	1.0 D + 1.0 S (All Spans)

System : Roof
 Member Type : Joist
 Building Use : Residential
 Building Code : IBC 2018
 Design Methodology : ASD
 Member Pitch : 0/12

- Deflection criteria: LL (L/360) and TL (L/240).
- Allowed moment does not reflect the adjustment for the beam stability factor.

Supports	Bearing Length			Loads to Supports (lbs)				Accessories
	Total	Available	Required	Dead	Roof Live	Snow	Total	
1 - Stud wall - HF	5.50"	4.25"	1.75"	390	312	390	1092	1 1/4" Rim Board
2 - Hanger on 16" PSL beam	5.50"	Hanger ¹	1.75" / - ²	393	314	393	1100	See note ¹

- Rim Board is assumed to carry all loads applied directly above it, bypassing the member being designed.
- At hanger supports, the Total Bearing dimension is equal to the width of the material that is supporting the hanger
- ¹ See Connector grid below for additional information and/or requirements.
- ² Required Bearing Length / Required Bearing Length with Web Stiffeners

Lateral Bracing	Bracing Intervals	Comments
Top Edge (Lu)	3' 2" o/c	
Bottom Edge (Lu)	22' 11" o/c	

- TJI joists are only analyzed using Maximum Allowable bracing solutions.
- Maximum allowable bracing intervals based on applied load.

Connector: Simpson Strong-Tie							
Support	Model	Seat Length	Top Fasteners	Face Fasteners	Member Fasteners	Accessories	
2 - Top Mount Hanger	ITS1.81/16	2.00"	4-10dx1.5	2-10dx1.5	2-Strong-Grip		

- Refer to manufacturer notes and instructions for proper installation and use of all connectors.

Vertical Load	Location	Spacing	Dead (0.90)	Roof Live (non-snow: 1.25)	Snow (1.15)	Comments
1 - Uniform (PSF)	0 to 23' 6"	16"	25.0	20.0	25.0	Default Load

Weyerhaeuser Notes
 Weyerhaeuser warrants that the sizing of its products will be in accordance with Weyerhaeuser product design criteria and published design values. Weyerhaeuser expressly disclaims any other warranties related to the software. Use of this software is not intended to circumvent the need for a design professional as determined by the authority having jurisdiction. The designer of record, builder or framer is responsible to assure that this calculation is compatible with the overall project. Accessories (Rim Board, Blocking Panels and Squash Blocks) are not designed by this software. Products manufactured at Weyerhaeuser facilities are third-party certified to sustainable forestry standards. Weyerhaeuser Engineered Lumber Products have been evaluated by ICC-ES under evaluation reports ESR-1153 and ESR-1387 and/or tested in accordance with applicable ASTM standards. For current code evaluation reports, Weyerhaeuser product literature and installation details refer to www.weyerhaeuser.com/woodproducts/document-library.
 The product application, input design loads, dimensions and support information have been provided by ForteWEB Software Operator

ForteWEB Software Operator	Job Notes
dong shin D.S. Engineering PC (425) 338-4776 shin_don@hotmail.com	



4/25/2022 8:24:19 AM UTC
 ForteWEB v3.2, Engine: V8.2.0.17, Data: V8.1.0.16

File Name: Strant
 00342
 Page 1 / 1

Level, Roof: Joist
1 piece(s) 16" TJI® 110 @ 16" OC

Overall Length: 10' 6"

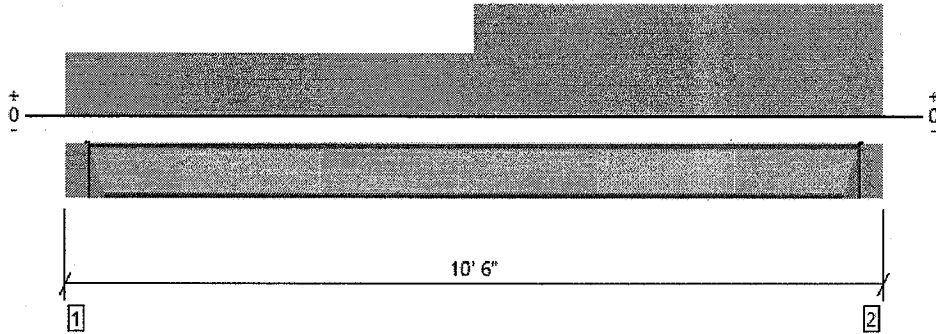

All locations are measured from the outside face of left support (or left cantilever end). All dimensions are horizontal.

Design Results	Actual @ Location	Allowed	Result	LDf	Load: Combination (Pattern)
Member Reaction (lbs)	423 @ 10' 1/2"	910 (1.75")	Passed (47%)	1.00	1.0 D + 1.0 L (All Spans)
Shear (lbs)	423 @ 10' 1/2"	2145	Passed (20%)	1.00	1.0 D + 1.0 L (All Spans)
Moment (Ft-lbs)	994 @ 5' 9 7/8"	4922	Passed (20%)	1.15	1.0 D + 0.75 L + 0.75 S (All Spans)
Live Load Defl. (in)	0.028 @ 5' 5 1/2"	0.319	Passed (L/999+)	--	1.0 D + 0.75 L + 0.75 S (All Spans)
Total Load Defl. (in)	0.043 @ 5' 4 1/2"	0.479	Passed (L/999+)	--	1.0 D + 0.75 L + 0.75 S (All Spans)

System : Roof
 Member Type : Joist
 Building Use : Residential
 Building Code : IBC 2018
 Design Methodology : ASD
 Member Pitch : 0/12

- Deflection criteria: LL (L/360) and TL (L/240).
- Allowed moment does not reflect the adjustment for the beam stability factor.

Supports	Bearing Length			Loads to Supports (lbs)					Accessories
	Total	Available	Required	Dead	Floor Live	Roof Live	Snow	Total	
1 - Hanger on 16" PSL beam	5.50"	Hanger ¹	1.75" / - ²	167	96	140	175	578	See note ¹
2 - Hanger on 16" PSL beam	5.50"	Hanger ¹	1.75" / - ²	148	324	140	175	787	See note ¹

- At hanger supports, the Total Bearing dimension is equal to the width of the material that is supporting the hanger
- ¹ See Connector grid below for additional information and/or requirements.
- ² Required Bearing Length / Required Bearing Length with Web Stiffeners

Lateral Bracing	Bracing Intervals	Comments
Top Edge (Lu)	6' 10" o/c	
Bottom Edge (Lu)	9' 7" o/c	

- TJI joists are only analyzed using Maximum Allowable bracing solutions.
- Maximum allowable bracing intervals based on applied load.

Connector: Simpson Strong-Tie							
Support	Model	Seat Length	Top Fasteners	Face Fasteners	Member Fasteners	Accessories	
1 - Top Mount Hanger	ITS1.81/16	2.00"	4-10dx1.5	2-10dx1.5	2-Strong-Grip		
2 - Top Mount Hanger	ITS1.81/16	2.00"	4-10dx1.5	2-10dx1.5	2-Strong-Grip		

- Refer to manufacturer notes and instructions for proper installation and use of all connectors.

Vertical Loads	Location	Spacing	Dead (0.90)	Floor Live (1.00)	Roof Live (non-snow: 1.25)	Snow (1.15)	Comments
1 - Uniform (PSF)	0 to 5' 3"	16"	25.0	-	20.0	25.0	Default Load
2 - Uniform (PSF)	5' 3" to 10' 6"	16"	20.0	60.0	20.0	25.0	

Weyerhaeuser Notes

Weyerhaeuser warrants that the sizing of its products will be in accordance with Weyerhaeuser product design criteria and published design values. Weyerhaeuser expressly disclaims any other warranties related to the software. Use of this software is not intended to circumvent the need for a design professional as determined by the authority having jurisdiction. The designer of record, builder or framer is responsible to assure that this calculation is compatible with the overall project. Accessories (Rim Board, Blocking Panels and Squash Blocks) are not designed by this software. Products manufactured at Weyerhaeuser facilities are third-party certified to sustainable forestry standards. Weyerhaeuser Engineered Lumber Products have been evaluated by ICC-ES under evaluation reports ESR-1153 and ESR-1387 and/or tested in accordance with applicable ASTM standards. For current code evaluation reports, Weyerhaeuser product literature and installation details refer to www.weyerhaeuser.com/woodproducts/document-library.

The product application, input design loads, dimensions and support information have been provided by ForteWEB Software Operator

ForteWEB Software Operator	Job Notes
dong shin D.S. Engineering PC (425) 338-4776 shin_don@hotmail.com	



4/25/2022 8:28:20 AM UTC
 ForteWEB v3.2, Engine: V8.2.0.17, Data: V8.1.0.16

File Name: Strant
 00343 Page 1 / 1

RB

Level, Roof: Joist
1 piece(s) 16" TJI® 110 @ 16" OC

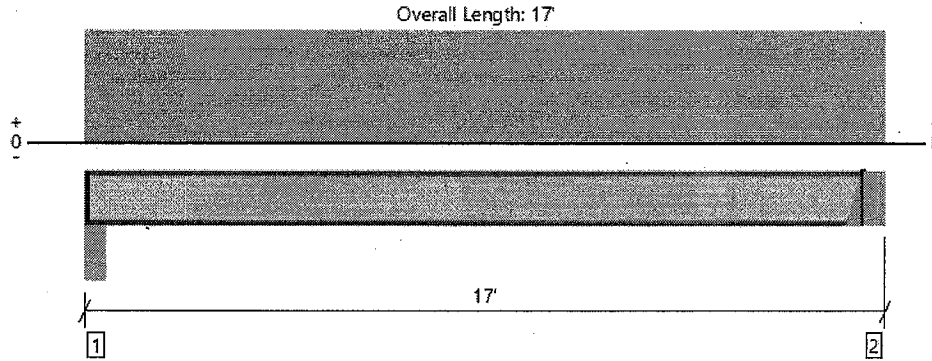

All locations are measured from the outside face of left support (or left cantilever end). All dimensions are horizontal.

Design Results	Actual @ Location	Allowed	Result	LDf	Load: Combination (Pattern)
Member Reaction (lbs)	916 @ 16' 6 1/2"	916 (1.77")	Passed (100%)	1.00	1.0 D + 1.0 L (All Spans)
Shear (lbs)	916 @ 16' 6 1/2"	2145	Passed (43%)	1.00	1.0 D + 1.0 L (All Spans)
Moment (Ft-lbs)	3703 @ 8' 5 1/2"	4280	Passed (87%)	1.00	1.0 D + 1.0 L (All Spans)
Live Load Defl. (in)	0.281 @ 8' 5 1/2"	0.539	Passed (L/690)	--	1.0 D + 0.75 L + 0.75 S (All Spans)
Total Load Defl. (in)	0.391 @ 8' 5 1/2"	0.808	Passed (L/496)	--	1.0 D + 0.75 L + 0.75 S (All Spans)

System : Roof
 Member Type : Joist
 Building Use : Residential
 Building Code : IBC 2018
 Design Methodology : ASD
 Member Pitch : 0/12

- Deflection criteria: LL (L/360) and TL (L/240).
- Allowed moment does not reflect the adjustment for the beam stability factor.

Supports	Bearing Length			Loads to Supports (lbs)				Accessories
	Total	Available	Required	Dead	Floor Live	Snow	Total	
1 - Beam - HF	5.50"	4.25"	1.89"	282	677	282	1241	1 1/4" Rim Board
2 - Hanger on 16" PSL beam	5.50"	Hanger ¹	1.77" / - ²	285	683	285	1253	See note ¹

- Rim Board is assumed to carry all loads applied directly above it, bypassing the member being designed.
- At hanger supports, the Total Bearing dimension is equal to the width of the material that is supporting the hanger
- ¹ See Connector grid below for additional information and/or requirements.
- ² Required Bearing Length / Required Bearing Length with Web Stiffeners

Lateral Bracing	Bracing Intervals	Comments
Top Edge (Lu)	3' 4" o/c	
Bottom Edge (Lu)	16' 5" o/c	

- TJI joists are only analyzed using Maximum Allowable bracing solutions.
- Maximum allowable bracing intervals based on applied load.

Connector: Simpson Strong-Tie							
Support	Model	Seat Length	Top Fasteners	Face Fasteners	Member Fasteners	Accessories	
2 - Top Mount Hanger	ITS1.81/16	2.00"	4-10dx1.5	2-10dx1.5	2-Strong-Grip		

- Refer to manufacturer notes and instructions for proper installation and use of all connectors.

Vertical Load	Location	Spacing	Dead (0.90)	Floor Live (1.00)	Snow (1.15)	Comments
1 - Uniform (PSF)	0 to 17'	16"	25.0	60.0	25.0	Default Load

Weyerhaeuser Notes
 Weyerhaeuser warrants that the sizing of its products will be in accordance with Weyerhaeuser product design criteria and published design values. Weyerhaeuser expressly disclaims any other warranties related to the software. Use of this software is not intended to circumvent the need for a design professional as determined by the authority having jurisdiction. The designer of record, builder or framer is responsible to assure that this calculation is compatible with the overall project. Accessories (Rim Board, Blocking Panels and Squash Blocks) are not designed by this software. Products manufactured at Weyerhaeuser facilities are third-party certified to sustainable forestry standards. Weyerhaeuser Engineered Lumber Products have been evaluated by ICC-ES under evaluation reports ESR-1153 and ESR-1387 and/or tested in accordance with applicable ASTM standards. For current code evaluation reports, Weyerhaeuser product literature and installation details refer to www.weyerhaeuser.com/woodproducts/document-library.
 The product application, input design loads, dimensions and support information have been provided by ForteWEB Software Operator

ForteWEB Software Operator	Job Notes
dong shin D.S. Engineering PC (425) 338-4776 shin_don@hotmail.com	



4/25/2022 8:38:09 AM UTC
 ForteWEB v3.2, Engine: V8.2.0.17, Data: V8.1.0.16

File Name: Strant
 00744 Page 1 / 1
R4

Level, Roof: Joist
1 piece(s) 16" TJI @ 110 @ 12" OC

Overall Length: 9' 6"

(2) - 16" TJI 110

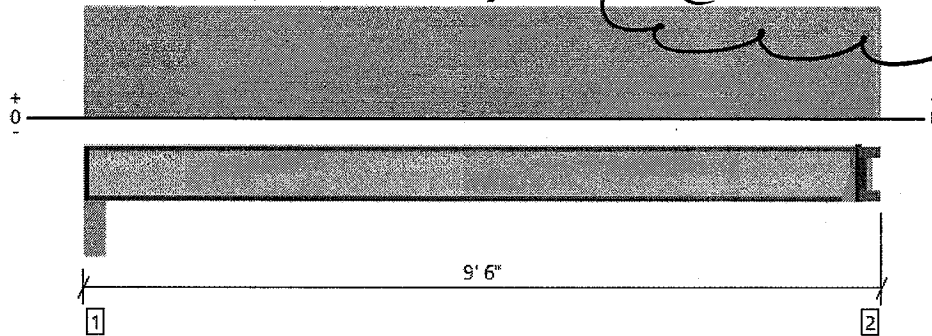

All locations are measured from the outside face of left support (or left cantilever end). All dimensions are horizontal.

Design Results	Actual @ Location	Allowed	Result	LDf	Load: Combination (Pattern)
Member Reaction (lbs)	1458 @ 9' 1/2"	1458 (3.10")	Passed (100%)	1.15	1.0 D + 0.75 L + 0.75 S (All Spans)
Shear (lbs)	1458 @ 9' 1/2"	2467	Passed (59%)	1.15	1.0 D + 0.75 L + 0.75 S (All Spans)
Moment (Ft-lbs)	3159 @ 4' 8 1/2"	4922	Passed (64%)	1.15	1.0 D + 0.75 L + 0.75 S (All Spans)
Live Load Defl. (in)	0.079 @ 4' 8 1/2"	0.289	Passed (L/999+)	--	1.0 D + 0.75 L + 0.75 S (All Spans)
Total Load Defl. (in)	0.122 @ 4' 8 1/2"	0.433	Passed (L/853)	--	1.0 D + 0.75 L + 0.75 S (All Spans)

System : Roof
 Member Type : Joist
 Building Use : Residential
 Building Code : IBC 2018
 Design Methodology : ASD
 Member Pitch : 0/12

- Deflection criteria: LL (L/360) and TL (L/240).
- Allowed moment does not reflect the adjustment for the beam stability factor.

Supports	Bearing Length			Loads to Supports (lbs)					Accessories
	Total	Available	Required	Dead	Floor Live	Roof Live	Snow	Total	
1 - Beam - HF	5.50"	4.25"	3.40"	560	744	250	622	2176	1 1/4" Rim Board
2 - Hanger on 16" TJI	5.50"	Hanger ¹	3.10" / - ²	570	757	254	633	2214	See note ¹

- Rim Board is assumed to carry all loads applied directly above it, bypassing the member being designed.
- At hanger supports, the Total Bearing dimension is equal to the width of the material that is supporting the hanger
- ¹ See Connector grid below for additional information and/or requirements.
- ² Required Bearing Length / Required Bearing Length with Web Stiffeners

Lateral Bracing	Bracing Intervals	Comments
Top Edge (Lu)	3' 9" o/c	
Bottom Edge (Lu)	8' 11" o/c	

- TJI joists are only analyzed using Maximum Allowable bracing solutions.
- Maximum allowable bracing intervals based on applied load.

Connector: Simpson Strong-Tie							
Support	Model	Seat Length	Top Fasteners	Face Fasteners	Member Fasteners	Accessories	
2 - Top Mount Hanger	WP1.81X H=15.938	4.00"	4-10dX1.5	N/A	2-10dX1.5	Web Stiffeners, Backer Block(s)	

- Refer to manufacturer notes and instructions for proper installation and use of all connectors.

Vertical Loads	Location	Spacing	Dead (0.90)	Floor Live (1.00)	Roof Live (non-snow: 1.25)	Snow (1.15)	Comments
1 - Uniform (PLF)	0 to 9' 6"	N/A	66.0	-	53.0	66.0	Default Load
2 - Uniform (PLF)	0 to 9' 6"	N/A	53.0	158.0	-	66.0	

Weyerhaeuser Notes

Weyerhaeuser warrants that the sizing of its products will be in accordance with Weyerhaeuser product design criteria and published design values. Weyerhaeuser expressly disclaims any other warranties related to the software. Use of this software is not intended to circumvent the need for a design professional as determined by the authority having jurisdiction. The designer of record, builder or framer is responsible to assure that this calculation is compatible with the overall project. Accessories (Rim Board, Blocking Panels and Squash Blocks) are not designed by this software. Products manufactured at Weyerhaeuser facilities are third-party certified to sustainable forestry standards. Weyerhaeuser Engineered Lumber Products have been evaluated by ICC-ES under evaluation reports ESR-1153 and ESR-1387 and/or tested in accordance with applicable ASTM standards. For current code evaluation reports, Weyerhaeuser product literature and installation details refer to www.weyerhaeuser.com/woodproducts/document-library.

The product application, input design loads, dimensions and support information have been provided by ForteWEB Software Operator

ForteWEB Software Operator	Job Notes
dong shin D.S. Engineering PC (425) 338-4776 shin_don@hotmail.com	



4/25/2022 8:51:33 AM UTC
 ForteWEB v3.2, Engine: V8.2.0.17, Data: V8.1.0.16

File Name: Strant
 00345 Page 1 / 1

Handwritten notes and arrows:
 25% (5.25/2)
 20% (5.25/2)
 25% (5.25/2)
 20% (5.25/2)
 60% (5.25/2)

Level, Roof: Joist
 1 piece(s) 16" TJI@ 110 @ 12" OC

(2) - 16" TJI 110

Overall Length: 10' 6"

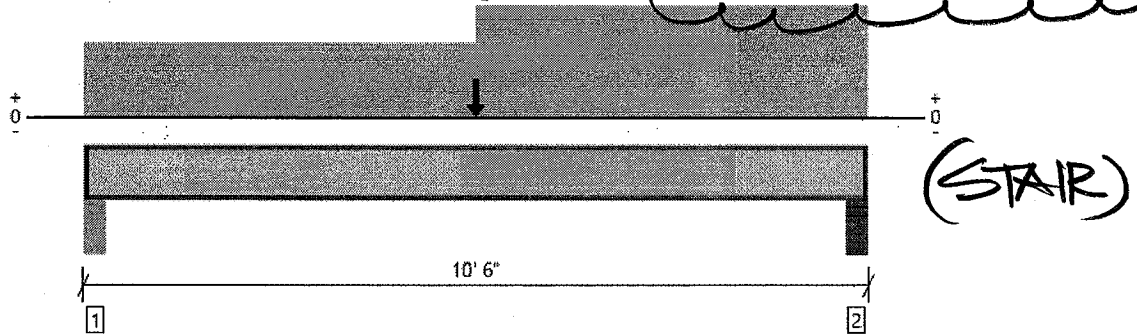

All locations are measured from the outside face of left support (or left cantilever end). All dimensions are horizontal.

Design Results	Actual @ Location	Allowed	Result	LDf	Load: Combination (Pattern)
Member Reaction (lbs)	1176 @ 10' 1 1/2"	1581 (3.50")	Passed (74%)	1.15	1.0 D + 0.75 L + 0.75 S (All Spans)
Shear (lbs)	1146 @ 10' 1/2"	2467	Passed (46%)	1.15	1.0 D + 0.75 L + 0.75 S (All Spans)
Moment (Ft-lbs)	4627 @ 5' 3"	4922	Passed (94%)	1.15	1.0 D + 0.75 L + 0.75 S (All Spans)
Live Load Defl. (in)	0.120 @ 5' 3"	0.325	Passed (L/978)	--	1.0 D + 0.75 L + 0.75 S (All Spans)
Total Load Defl. (in)	0.185 @ 5' 3"	0.488	Passed (L/633)	--	1.0 D + 0.75 L + 0.75 S (All Spans)

System : Roof
 Member Type : Joist
 Building Use : Residential
 Building Code : IBC 2018
 Design Methodology : ASD
 Member Pitch : 0/12

- Deflection criteria: LL (L/360) and TL (L/240).
- Allowed moment does not reflect the adjustment for the beam stability factor.

Supports	Bearing Length			Loads to Supports (lbs)					Accessories
	Total	Available	Required	Dead	Floor Live	Roof Live	Snow	Total	
1 - Beam - HF	5.50"	4.25"	1.82"	405	448	206	441	1500	1 1/4" Rim Board
2 - Stud wall - HF	5.50"	4.25"	2.18"	391	617	149	441	1598	1 1/4" Rim Board

• Rim Board is assumed to carry all loads applied directly above it, bypassing the member being designed.

Lateral Bracing	Bracing Intervals	Comments
Top Edge (Lu)	3' o/c	
Bottom Edge (Lu)	10' 4" o/c	

- TJI joists are only analyzed using Maximum Allowable bracing solutions.
- Maximum allowable bracing intervals based on applied load.

Vertical Loads	Location	Spacing	Dead (0.90)	Floor Live (1.00)	Roof Live (non-snow: 1.25)	Snow (1.15)	Comments
1 - Uniform (PLF)	0 to 5' 3"	N/A	25.0	-	20.0	25.0	Default Load
2 - Uniform (PLF)	5' 3" to 10' 6"	N/A	20.0	60.0	-	25.0	
3 - Point (lb)	5' 3"	N/A	560	750	250	620	

Weyerhaeuser Notes
 Weyerhaeuser warrants that the sizing of its products will be in accordance with Weyerhaeuser product design criteria and published design values. Weyerhaeuser expressly disclaims any other warranties related to the software. Use of this software is not intended to circumvent the need for a design professional as determined by the authority having jurisdiction. The designer of record, builder or framer is responsible to assure that this calculation is compatible with the overall project. Accessories (Rim Board, Blocking Panels and Squash Blocks) are not designed by this software. Products manufactured at Weyerhaeuser facilities are third-party certified to sustainable forestry standards. Weyerhaeuser Engineered Lumber Products have been evaluated by ICC-ES under evaluation reports ESR-1153 and ESR-1387 and/or tested in accordance with applicable ASTM standards. For current code evaluation reports, Weyerhaeuser product literature and installation details refer to www.weyerhaeuser.com/woodproducts/document-library.
 The product application, input design loads, dimensions and support information have been provided by ForteWEB Software Operator

- DL: $(20 + 25) \#$ (5.25' x 9.5' / 4)
- LL: $60 \#$ (5.25' x 9.5' / 4)
- Lr: $20 \#$ (5.25' x 9.5' / 4)
- SL: $25 \#$ (10.5' x 9.5' / 4)

ForteWEB Software Operator	Job Notes
dong shin D.S. Engineering PC (425) 338-4776 shin_don@hotmail.com	



Wood Beam

File: examples.ec6
Software copyright ENERCALC, INC. 1983-2020, Build:12.20.8.24

Lic. #: KW-06010224

D.S. ENGINEERING PC

DESCRIPTION: header (RP)

CODE REFERENCES

(TYP. U.O.N.) @ NOT BEARING WALL

Calculations per NDS 2018, IBC 2018, CBC 2019, ASCE 7-16

Load Combination Set : IBC 2018

Material Properties

Analysis Method : Allowable Stress Design
Load Combination IBC 2018

Fb +	900 psi	E : Modulus of Elasticity	
Fb -	900 psi	Ebend-xx	1600 ksi
Fc - Prll	1350 psi	Eminbend -xx	580 ksi
Fc - Perp	625 psi		
Fv	180 psi		
Ft	575 psi	Density	31.21 pcf

Wood Species : Douglas Fir-Larch
Wood Grade : No.2

Beam Bracing : Completely Unbraced

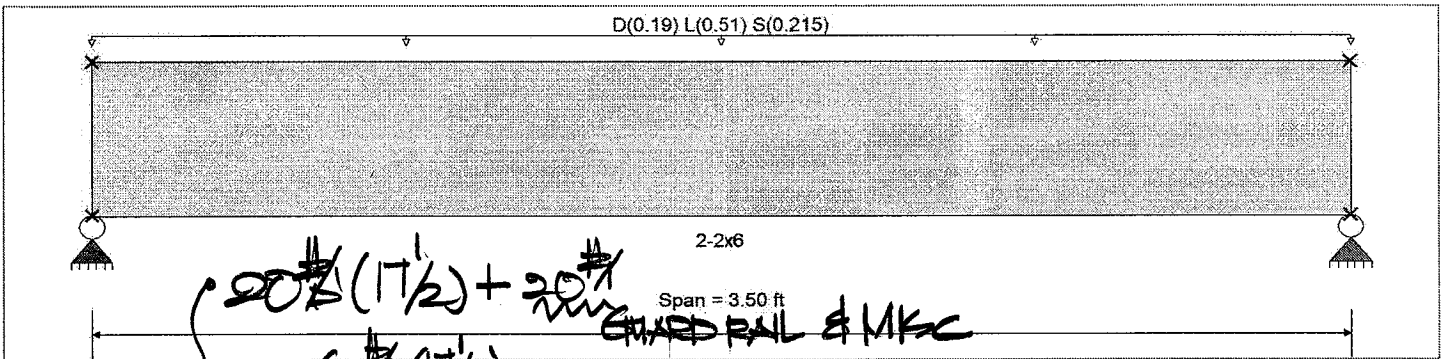

Applied Loads

Beam self weight calculated and added to loads

Uniform Load : D = 0.190, L = 0.510, S = 0.2150, Tributary Width = 1.0 ft

Service loads entered. Load Factors will be applied for calculations.

DESIGN SUMMARY

Design OK

Maximum Bending Stress Ratio	=	0.734	1	Maximum Shear Stress Ratio	=	0.463	: 1
Section used for this span		2-2x6		Section used for this span		2-2x6	
fb: Actual	=	854.76	psi	fv: Actual	=	83.34	psi
Fb: Allowable	=	1,164.46	psi	Fv: Allowable	=	180.00	psi
Load Combination		+D+L+H		Load Combination		+D+L+H	
Location of maximum on span	=	1.750	ft	Location of maximum on span	=	3.053	ft
Span # where maximum occurs	=	Span # 1		Span # where maximum occurs	=	Span # 1	
Maximum Deflection							
Max Downward Transient Deflection		0.026	in	Ratio =		1613	>=240
Max Upward Transient Deflection		0.000	in	Ratio =		0	<240
Max Downward Total Deflection		0.038	in	Ratio =		1116	>=180
Max Upward Total Deflection		0.000	in	Ratio =		0	<180

Overall Maximum Deflections

Load Combination	Span	Max. "-" Defl	Location in Span	Load Combination	Max. "+" Defl	Location in Span
+D+0.750L+0.750S+0.5250E+H	1	0.0376	1.763		0.0000	0.000

Vertical Reactions

Support notation : Far left is #1

Values in KIPS

Load Combination	Support 1	Support 2
Overall MAXimum	1.290	1.290
Overall MINimum	0.376	0.376
+D+H	0.339	0.339
+D+L+H	1.231	1.231
+D+Lr+H	0.339	0.339
+D+S+H	0.715	0.715
+D+0.750Lr+0.750L+H	1.008	1.008
+D+0.750L+0.750S+H	1.290	1.290
+D+0.60W+H	0.339	0.339
+D+0.70E+H	0.339	0.339

ELEVATOR

$W_{DL} = 25 \# (24 \frac{1}{2}) = 300$
 $W_{LH} = 20 \# (11) = 240$
 $W_{DL} = 25 \# (11) = 300$

Wood Beam

File: examples.ec6

Software copyright ENERCALC, INC. 1983-2020, Build: 12.20.8.24

Lic. #: KW-06010224

D.S. ENGINEERING PC

DESCRIPTION: header

(R)**Vertical Reactions**

Support notation : Far left is #1

Values in KIPS

Load Combination	Support 1	Support 2
+D+0.750Lr+0.750L+0.450W+H	1.008	1.008
+D+0.750L+0.750S+0.450W+H	1.290	1.290
+D+0.750L+0.750S+0.5250E+H	1.290	1.290
+0.60D+0.60W+0.60H	0.203	0.203
+0.60D+0.70E+0.60H	0.203	0.203
D Only	0.339	0.339
L Only	0.893	0.893
S Only	0.376	0.376
H Only		

Wood Beam

File: examples.ecb
 Software copyright ENERCALC, INC. 1983-2020, Build:12.20.8.24
 D.S. ENGINEERING PC

Lic. #: KW-06010224

DESCRIPTION: header (R2)

CODE REFERENCES

Calculations per NDS 2018, IBC 2018, CBC 2019, ASCE 7-16

Load Combination Set : IBC 2018

Material Properties

Analysis Method : Allowable Stress Design
 Load Combination IBC 2018

Fb +	875 psi	E : Modulus of Elasticity	
Fb -	875 psi	Ebend- xx	1300 ksi
Fc - Prll	600 psi	Eminbend - xx	470 ksi
Fc - Perp	625 psi		
Fv	170 psi		
Ft	425 psi	Density	31.21 pcf

Wood Species : Douglas Fir-Larch
 Wood Grade : No.2

Beam Bracing : Completely Unbraced

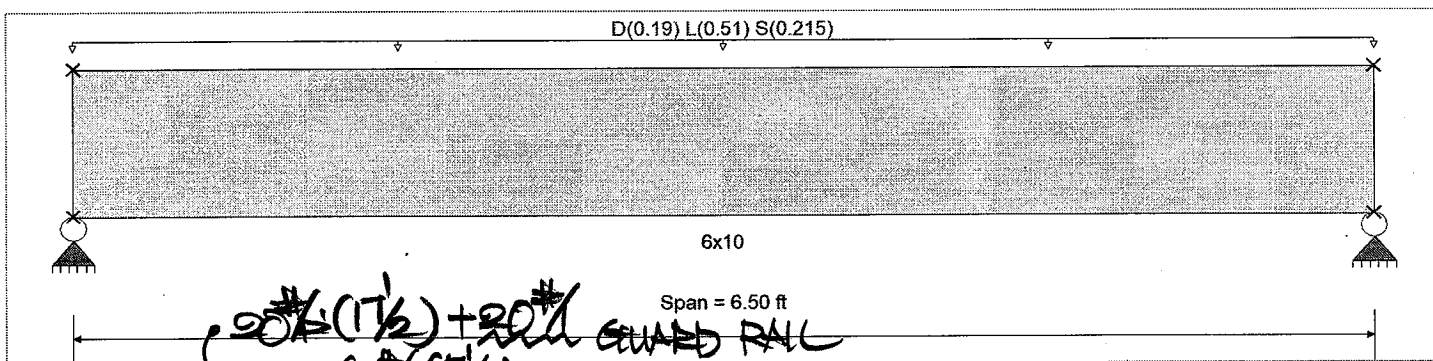

Applied Loads

Beam self weight calculated and added to loads

Uniform Load : D = 0.190, L = 0.510, S = 0.2150, Tributary Width = 1.0 ft

Service loads entered. Load Factors will be applied for calculations.

DESIGN SUMMARY

Design OK

Maximum Bending Stress Ratio	=	0.625	1	Maximum Shear Stress Ratio	=	0.296	: 1
Section used for this span		6x10		Section used for this span		6x10	
fb: Actual	=	544.91	psi	fv: Actual	=	50.38	psi
Fb: Allowable	=	871.44	psi	Fv: Allowable	=	170.00	psi
Load Combination		+D+L		Load Combination		+D+L	
Location of maximum on span	=	3.250	ft	Location of maximum on span	=	5.717	ft
Span # where maximum occurs	=	Span # 1		Span # where maximum occurs	=	Span # 1	
Maximum Deflection							
Max Downward Transient Deflection		0.040	in	Ratio =		1933	>=360
Max Upward Transient Deflection		0.000	in	Ratio =		0	<360
Max Downward Total Deflection		0.059	in	Ratio =		1323	>=180
Max Upward Total Deflection		0.000	in	Ratio =		0	<180

Overall Maximum Deflections

Load Combination	Span	Max. "-" Defl	Location in Span	Load Combination	Max. "+" Defl	Location in Span
+D+0.750L+0.750S	1	0.0589	3.274		0.0000	0.000

Vertical Reactions

Support notation : Far left is #1

Values in KIPS

Load Combination	Support 1	Support 2
Overall MAXimum	2.421	2.421
Overall MINimum	0.699	0.699
D Only	0.654	0.654
+D+L	2.312	2.312
+D+S	1.353	1.353
+D+0.750L	1.897	1.897
+D+0.750L+0.750S	2.421	2.421
+0.60D	0.393	0.393
L Only	1.658	1.658
S Only	0.699	0.699

Wood Beam

File: examples.ec6
Software copyright: ENERCALC, INC. 1983-2020, Build: 12.20.8.24

Lic. #: KW-06010224

D.S. ENGINEERING PC

DESCRIPTION: header

R3

CODE REFERENCES

Calculations per NDS 2018, IBC 2018, CBC 2019, ASCE 7-16

Load Combination Set : IBC 2018

Material Properties

Analysis Method : Allowable Stress Design
Load Combination IBC 2018

Fb +	900 psi	E : Modulus of Elasticity	
Fb -	900 psi	Ebend-xx	1600 ksi
Fc - Prll	1350 psi	Eminbend -xx	580 ksi
Fc - Perp	625 psi		
Fv	180 psi		
Ft	575 psi	Density	31.21 pcf

Wood Species : Douglas Fir-Larch
Wood Grade : No.2

Beam Bracing : Completely Unbraced

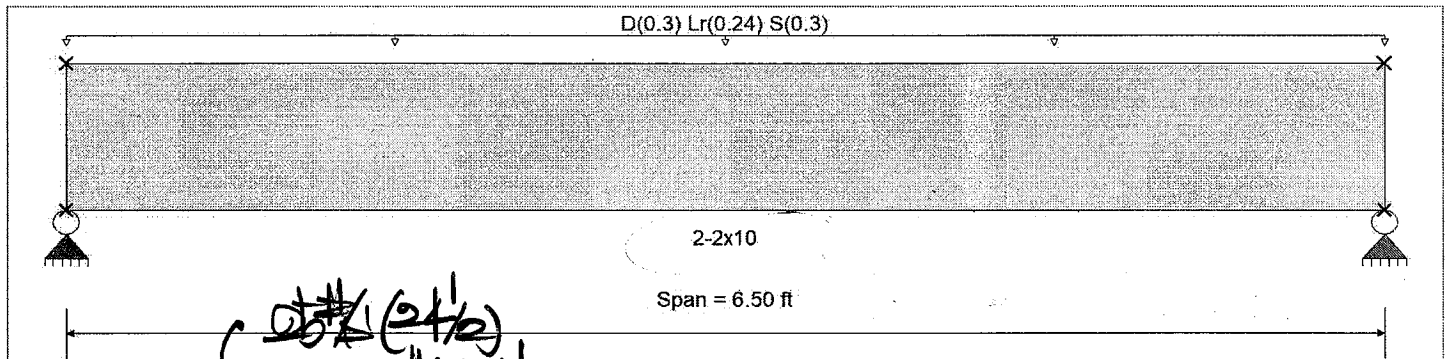

Applied Loads

Service loads entered. Load Factors will be applied for calculations.

Beam self weight calculated and added to loads

Uniform Load : D = 0.30, Lr = 0.240, S = 0.30, Tributary Width = 1.0 ft

DESIGN SUMMARY

Design OK

Maximum Bending Stress Ratio	=	0.802	1	Maximum Shear Stress Ratio	=	0.394	1
Section used for this span		2-2x10		Section used for this span		2-2x10	
fb: Actual	=	897.73	psi	fv: Actual	=	81.59	psi
Fb: Allowable	=	1,119.24	psi	Fv: Allowable	=	207.00	psi
Load Combination		+D+S+H		Load Combination		+D+S+H	
Location of maximum on span	=	3.250	ft	Location of maximum on span	=	5.741	ft
Span # where maximum occurs	=	Span # 1		Span # where maximum occurs	=	Span # 1	
Maximum Deflection							
Max Downward Transient Deflection		0.038	in	Ratio =		2037	>=240
Max Upward Transient Deflection		0.000	in	Ratio =		0	<240
Max Downward Total Deflection		0.077	in	Ratio =		1008	>=180
Max Upward Total Deflection		0.000	in	Ratio =		0	<180

Overall Maximum Deflections

Load Combination	Span	Max. "+" Defl	Location in Span	Load Combination	Max. "+" Defl	Location in Span
+D+S+H	1	0.0773	3.274		0.0000	0.000

Vertical Reactions

Support notation : Far left is #1

Values in KIPS

Load Combination	Support 1	Support 2
Overall MAXimum	1.970	1.970
Overall MINimum	0.975	0.975
+D+H	0.995	0.995
+D+L+H	0.995	0.995
+D+Lr+H	1.775	1.775
+D+S+H	1.970	1.970
+D+0.750Lr+0.750L+H	1.580	1.580
+D+0.750L+0.750S+H	1.726	1.726
+D+0.60W+H	0.995	0.995
+D+0.70E+H	0.995	0.995

Wood Beam

File: examples.ec6

Software copyright ENERCALC, INC. 1983-2020, Build:12.20.8.24

Lic. #: KW-06010224

D.S. ENGINEERING PC

DESCRIPTION: header

(R3)**Vertical Reactions**

Support notation : Far left is #1

Values in KIPS

Load Combination	Support 1	Support 2
+D+0.750Lr+0.750L+0.450W+H	1.580	1.580
+D+0.750L+0.750S+0.450W+H	1.726	1.726
+D+0.750L+0.750S+0.5250E+H	1.726	1.726
+0.60D+0.60W+0.60H	0.597	0.597
+0.60D+0.70E+0.60H	0.597	0.597
D Only	0.995	0.995
Lr Only	0.780	0.780
S Only	0.975	0.975
H Only		

Wood Beam

File: examples.ec6
 Software copyright ENERCALC, INC. 1983-2020, Build:12.20.8.24
 D.S. ENGINEERING PC

Lic. #: KW-06010224

DESCRIPTION: header



CODE REFERENCES

Calculations per NDS 2018, IBC 2018, CBC 2019, ASCE 7-16
 Load Combination Set : IBC 2018

Material Properties

Analysis Method : Allowable Stress Design	Fb +	900 psi	E : Modulus of Elasticity	
Load Combination IBC 2018	Fb -	900 psi	Ebend-xx	1600ksi
	Fc - Prll	1350 psi	Eminbend -xx	580ksi
Wood Species : Douglas Fir-Larch	Fc - Perp	625 psi		
Wood Grade : No.2	Fv	180 psi		
	Ft	575 psi	Density	31.21pcf
Beam Bracing : Completely Unbraced				

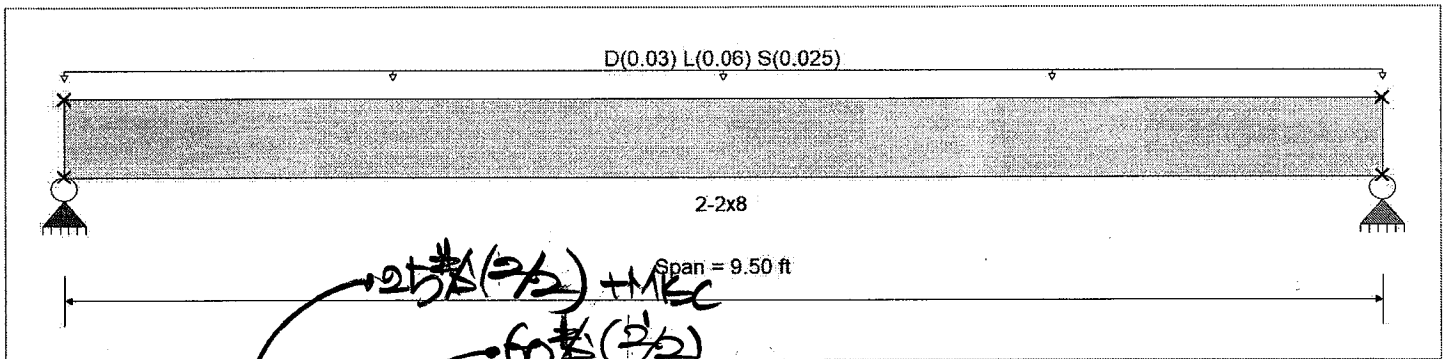

Applied Loads

Beam self weight calculated and added to loads

Uniform Load : D = 0.030, L = 0.060, S = 0.0250, Tributary Width = 1.0 ft

DESIGN SUMMARY

Design OK

Maximum Bending Stress Ratio =	0.460 1	Maximum Shear Stress Ratio =	0.151 : 1
Section used for this span	2-2x8	Section used for this span	2-2x8
fb: Actual =	487.87 psi	fv: Actual =	27.18 psi
Fb: Allowable =	1,061.57 psi	Fv: Allowable =	180.00 psi
Load Combination =	+D+L+H	Load Combination =	+D+L+H
Location of maximum on span =	4.750ft	Location of maximum on span =	8.911 ft
Span # where maximum occurs =	Span # 1	Span # where maximum occurs =	Span # 1
Maximum Deflection			
Max Downward Transient Deflection	0.073 in Ratio =	1571 >=240	
Max Upward Transient Deflection	0.000 in Ratio =	0 <240	
Max Downward Total Deflection	0.119 in Ratio =	957 >=180	
Max Upward Total Deflection	0.000 in Ratio =	0 <180	

Overall Maximum Deflections

Load Combination	Span	Max. "-" Defl	Location in Span	Load Combination	Max. "+" Defl	Location in Span
+D+0.750L+0.750S+0.5250E+H	1	0.1191	4.785		0.0000	0.000

Vertical Reactions

Support notation : Far left is #1

Values in KIPS

Load Combination	Support 1	Support 2
Overall MAXimum	0.468	0.468
Overall MINimum	0.119	0.119
+D+H	0.165	0.165
+D+L+H	0.450	0.450
+D+Lr+H	0.165	0.165
+D+S+H	0.284	0.284
+D+0.750Lr+0.750L+H	0.379	0.379
+D+0.750L+0.750S+H	0.468	0.468
+D+0.60W+H	0.165	0.165
+D+0.70E+H	0.165	0.165

Wood Beam

Lic. #: KW-06010224

File: examples.ec6
Software copyright ENERCALC, INC. 1983-2020. Build: 12.20.8.24

D.S. ENGINEERING PC

DESCRIPTION: header

R4

Vertical Reactions

Support notation : Far left is #1

Values in KIPS

Load Combination	Support 1	Support 2
+D+0.750Lr+0.750L+0.450W+H	0.379	0.379
+D+0.750L+0.750S+0.450W+H	0.468	0.468
+D+0.750L+0.750S+0.5250E+H	0.468	0.468
+0.60D+0.60W+0.60H	0.099	0.099
+0.60D+0.70E+0.60H	0.099	0.099
D Only	0.165	0.165
L Only	0.285	0.285
S Only	0.119	0.119
H Only		

Wood Beam

Lic. #: KW-06010224

DESCRIPTION: flat roof

CODE REFERENCES

Calculations per NDS 2018, IBC 2018, CBC 2019, ASCE 7-16
 Load Combination Set : IBC 2018

Material Properties

Analysis Method : Allowable Stress Design	Fb +	900 psi	E : Modulus of Elasticity	
Load Combination IBC 2018	Fb -	900 psi	Ebend- xx	1600ksi
	Fc - Prll	1350 psi	Eminbend - xx	580ksi
Wood Species : Douglas Fir-Larch	Fc - Perp	625 psi		
Wood Grade : No.2	Fv	180 psi		
	Ft	575 psi	Density	31.21pcf
Beam Bracing : Beam is Fully Braced against lateral-torsional buckling			Repetitive Member Stress Increase	

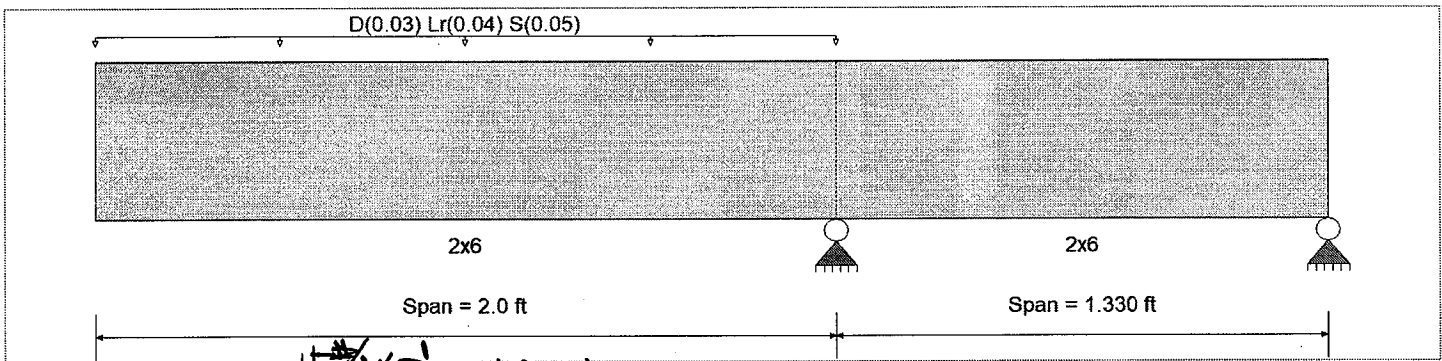

Applied Loads

Service loads entered. Load Factors will be applied for calculations.

Load for Span Number 1

Uniform Load : D = 0.030, Lr = 0.040, S = 0.050, Tributary Width = 1.0 ft

DESIGN SUMMARY

Design OK

Maximum Bending Stress Ratio	=	0.164	1	Maximum Shear Stress Ratio	=	0.108	1
Section used for this span	=	2x6		Section used for this span	=	2x6	
fb: Actual	=	253.88	psi	fv: Actual	=	22.43	psi
Fb: Allowable	=	1,547.33	psi	Fv: Allowable	=	207.00	psi
Load Combination	=	+D+S		Load Combination	=	+D+S	
Location of maximum on span	=	2.000	ft	Location of maximum on span	=	1.542	ft
Span # where maximum occurs	=	Span # 1		Span # where maximum occurs	=	Span # 1	
Maximum Deflection							
Max Downward Transient Deflection		0.010	in	Ratio =		4888	>=360
Max Upward Transient Deflection		0.000	in	Ratio =		0	<360
Max Downward Total Deflection		0.016	in	Ratio =		3054	>=180
Max Upward Total Deflection		-0.001	in	Ratio =		16684	>=180

Overall Maximum Deflections

Load Combination	Span	Max. "-" Defl	Location in Span	Load Combination	Max. "+" Defl	Location in Span
+D+S	1	0.0157	0.000		0.0000	0.000
	2	0.0000	0.000	+D+S	-0.0010	0.565

Vertical Reactions

Support notation : Far left is #1

Values in KIPS

Load Combination	Support 1	Support 2	Support 3
Overall MAXimum	0.280	-0.120	
Overall MINimum	0.175	-0.045	
D Only	0.105	-0.045	
+D+L	0.105	-0.045	
+D+Lr	0.245	-0.105	
+D+S	0.280	-0.120	
+D+0.750Lr+0.750L	0.210	-0.090	
+D+0.750L+0.750S	0.237	-0.102	
+0.60D	0.063	-0.027	

→ IGNORE @ TJI DESIGN
 → MAKE A CONSERVATIVE

Wood Beam

File: examples.ec6

Software copyright ENERCALC, INC. 1983-2020, Build:12.20.8.24

Lic. # : KW-06010224

D.S. ENGINEERING PC

DESCRIPTION: flat roof**Vertical Reactions**

Support notation : Far left is #1

Values in KIPS

Load Combination	Support 1	Support 2	Support 3
Lr Only		0.140	-0.060
S Only		0.175	-0.075

Wood Beam

Lic. #: KW-06010224

DESCRIPTION: header (R5)

CODE REFERENCES

Calculations per NDS 2018, IBC 2018, CBC 2019, ASCE 7-16

Load Combination Set : IBC 2018

Material Properties

Analysis Method : Allowable Stress Design
 Load Combination IBC 2018

Wood Species : DF/DF
 Wood Grade : 24F-V4

Beam Bracing : Completely Unbraced

Fb +	2400 psi	E : Modulus of Elasticity	
Fb -	1850 psi	Ebend- xx	1800 ksi
Fc - Prll	1650 psi	Eminbend - xx	950 ksi
Fc - Perp	650 psi	Ebend- yy	1600 ksi
Fv	265 psi	Eminbend - yy	850 ksi
Ft	1100 psi	Density	31.21 pcf

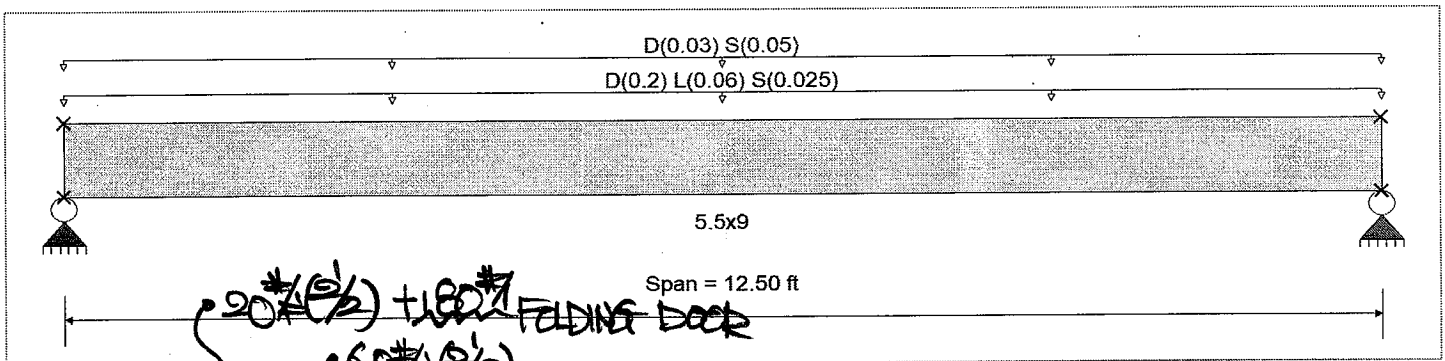

Applied Loads

Beam self weight calculated and added to loads

Uniform Load : D = 0.20, L = 0.060, S = 0.0250, Tributary Width = 1.0 ft
 Uniform Load : D = 0.030, S = 0.050, Tributary Width = 1.0 ft, (from flat roof)

Service loads entered. Load Factors will be applied for calculations.

DESIGN SUMMARY

Maximum Bending Stress Ratio	0.400 : 1	Maximum Shear Stress Ratio	=	0.190 : 1
Section used for this span	5.5x9	Section used for this span	=	5.5x9
fb: Actual	= 949.27 psi	fv: Actual	=	50.30 psi
Fb: Allowable	= 2,375.48 psi	Fv: Allowable	=	265.00 psi
Load Combination	= +D+L	Load Combination	=	+D+L
Location of maximum on span	= 6.250ft	Location of maximum on span	=	11.770 ft
Span # where maximum occurs	= Span # 1	Span # where maximum occurs	=	Span # 1
Maximum Deflection				
Max Downward Transient Deflection	0.069 in	Ratio =	2177	>=360
Max Upward Transient Deflection	0.000 in	Ratio =	0	<360
Max Downward Total Deflection	0.314 in	Ratio =	477	>=180
Max Upward Total Deflection	0.000 in	Ratio =	0	<180

Overall Maximum Deflections

Load Combination	Span	Max. " Defl	Location in Span	Load Combination	Max. "+" Defl	Location in Span
+D+0.750L+0.750S	1	0.3142	6.296		0.0000	0.000

Vertical Reactions

Load Combination	Support notation : Far left is #1		Values in KIPS	
	Support 1	Support 2		
Overall MAXimum	2.137	2.137		
Overall MINimum	0.469	0.469		
D Only	1.505	1.505		
+D+L	1.880	1.880		
+D+S	1.973	1.973		
+D+0.750L	1.786	1.786		
+D+0.750L+0.750S	2.137	2.137		
+0.60D	0.903	0.903		
L Only	0.375	0.375		

Wood Beam

File: examples.ec6
Software copyright: ENERCALC, INC. 1983-2020, Build: 12.20.8.24
D.S. ENGINEERING PC

Lic. # : KW-06010224

DESCRIPTION: header (R5)

Vertical Reactions

Support notation : Far left is #1

Values in KIPS

Load Combination	Support 1	Support 2
S Only	0.469	0.469

Wood Beam

Lic. #: KW-06010224

File: examples.ec6
 Software copyright ENERCALC, INC. 1983-2020, Build: 12.20.8.24
 D.S. ENGINEERING PC

DESCRIPTION: header (R6)

CODE REFERENCES

Calculations per NDS 2018, IBC 2018, CBC 2019, ASCE 7-16

Load Combination Set : IBC 2018

Material Properties

Analysis Method : Allowable Stress Design
 Load Combination IBC 2018

Wood Species : DF/DF
 Wood Grade : 24F-V4

Beam Bracing : Completely Unbraced

Fb +	2400 psi	E : Modulus of Elasticity	
Fb -	1850 psi	Ebend- xx	1800 ksi
Fc - Prll	1650 psi	Eminbend - xx	950 ksi
Fc - Perp	650 psi	Ebend- yy	1600 ksi
Fv	265 psi	Eminbend - yy	850 ksi
Ft	1100 psi	Density	31.21 pcf

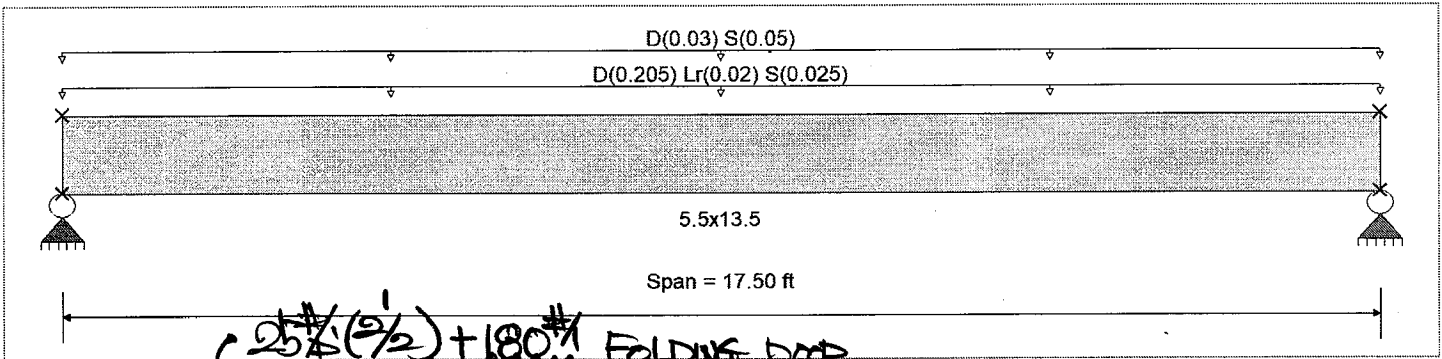

Applied Loads

Beam self weight calculated and added to loads

Uniform Load : D = 0.2050, Lr = 0.020, S = 0.0250, Tributary Width = 1.0 ft
 Uniform Load : D = 0.030, S = 0.050, Tributary Width = 1.0 ft, (from flat roof)

Service loads entered. Load Factors will be applied for calculations.

DESIGN SUMMARY

Maximum Bending Stress Ratio	=	0.336 : 1	Maximum Shear Stress Ratio	=	0.166 : 1
Section used for this span	=	5.5x13.5	Section used for this span	=	5.5x13.5
fb: Actual	=	896.66 psi	fv: Actual	=	50.49 psi
Fb: Allowable	=	2,669.59 psi	Fv: Allowable	=	304.75 psi
Load Combination	=	+D+S	Load Combination	=	+D+S
Location of maximum on span	=	8.750 ft	Location of maximum on span	=	0.000 ft
Span # where maximum occurs	=	Span # 1	Span # where maximum occurs	=	Span # 1
Maximum Deflection					
Max Downward Transient Deflection	=	0.078 in	Ratio =	=	2677 >= 360
Max Upward Transient Deflection	=	0.000 in	Ratio =	=	0 < 360
Max Downward Total Deflection	=	0.341 in	Ratio =	=	615 >= 180
Max Upward Total Deflection	=	0.000 in	Ratio =	=	0 < 180

Overall Maximum Deflections

Load Combination	Span	Max. "-" Defl	Location in Span	Load Combination	Max. "+" Defl	Location in Span
+D+S	1	0.3410	8.814		0.0000	0.000

Vertical Reactions

Load Combination	Support notation : Far left is #1	
	Support 1	Support 2
Overall MAXimum	2.853	2.853
Overall MINimum	0.656	0.656
D Only	2.197	2.197
+D+L	2.197	2.197
+D+Lr	2.372	2.372
+D+S	2.853	2.853
+D+0.750Lr+0.750L	2.328	2.328
+D+0.750L+0.750S	2.689	2.689
+0.60D	1.318	1.318

Wood Beam

File: examples.ec6
Software copyright ENERCALC, INC. 1983-2020, Build: 12.20.8.24
D.S. ENGINEERING PC

Lic. #: KW-06010224

DESCRIPTION: header (R6)

Vertical Reactions

Support notation : Far left is #1

Values in KIPS

Load Combination	Support 1	Support 2
Lr Only	0.175	0.175
S Only	0.656	0.656

Wood Beam

Lic. #: KW-06010224

File: examples.ec6
Software copyright ENERCALC, INC. 1983-2020, Build:12.20.8.24

D.S. ENGINEERING PC

DESCRIPTION: beam



CODE REFERENCES

Calculations per NDS 2018, IBC 2018, CBC 2019, ASCE 7-16
Load Combination Set : IBC 2018

Material Properties

Analysis Method : Allowable Stress Design
Load Combination IBC 2018

Fb +	2900 psi	E : Modulus of Elasticity	
Fb -	2900 psi	Ebend-xx	2200 ksi
Fc - Prll	2900 psi	Eminbend - xx	1118.19 ksi
Fc - Perp	750 psi		
Fv	290 psi		
Ft	2025 psi	Density	45.07 pcf

Wood Species : iLevel Truss Joist
Wood Grade : Parallam PSL 2.2E

Beam Bracing : Beam is Fully Braced against lateral-torsional buckling

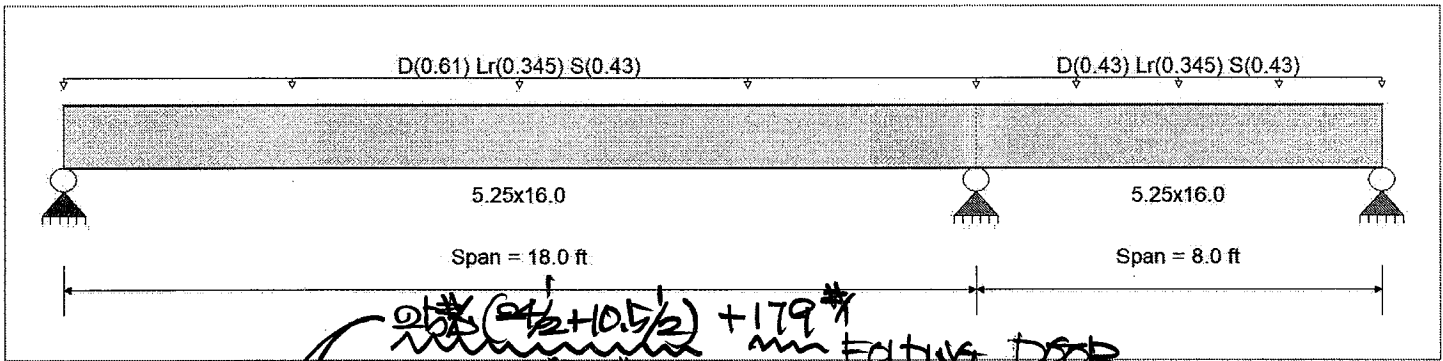

Applied Loads

Service loads entered. Load Factors will be applied for calculations.

Beam self weight calculated and added to loads
Load for Span Number 1

Uniform Load : D = 0.610, Lr = 0.3450, S = 0.430, Tributary Width = 1.0 ft

Load for Span Number 2

Uniform Load : D = 0.430, Lr = 0.3450, S = 0.430, Tributary Width = 1.0 ft

DESIGN SUMMARY

Design OK

Maximum Bending Stress Ratio	=	0.532	1	Maximum Shear Stress Ratio	=	0.535	: 1
Section used for this span	=	5.25x16.0		Section used for this span	=	5.25x16.0	
fb: Actual	=	1,718.51	psi	fv: Actual	=	178.30	psi
Fb: Allowable	=	3,230.19	psi	Fv: Allowable	=	333.50	psi
Load Combination	=	+D+S+H		Load Combination	=	+D+S+H	
Location of maximum on span	=	18.000ft		Location of maximum on span	=	16.693 ft	
Span # where maximum occurs	=	Span # 1		Span # where maximum occurs	=	Span # 1	
Maximum Deflection							
Max Downward Transient Deflection		0.145	in	Ratio =		1494	>=240
Max Upward Transient Deflection		-0.014	in	Ratio =		6710	>=240
Max Downward Total Deflection		0.362	in	Ratio =		596	>=180
Max Upward Total Deflection		-0.039	in	Ratio =		2487	>=180

Overall Maximum Deflections

Load Combination	Span	Max. "-" Defl	Location in Span	Load Combination	Max. "+" Defl	Location in Span
+D+S+H	1	0.3623	8.145	+D+S+H	0.0000	0.000
	2	0.0000	8.145		-0.0386	3.039

Vertical Reactions

Support notation : Far left is #1

Values in KIPS

Load Combination	Support 1	Support 2	Support 3
Overall MAXimum	7.814	18.934	-0.545
Overall MINimum	3.141	7.958	-0.545
+D+H	4.673	10.976	-0.545
+D+L+H	4.673	10.976	-0.545
+D+Lr+H	7.193	17.361	-0.481
+D+S+H	7.814	18.934	-0.465

Wood Beam

File: examples.ec6

Software copyright ENERCALC, INC. 1983-2020, Build:12.20.8.24

Lic. #: KW-06010224

D.S. ENGINEERING PC

DESCRIPTION: beam

**Vertical Reactions**

Support notation : Far left is #1

Values in KIPS

Load Combination	Support 1	Support 2	Support 3
+D+0.750Lr+0.750L+H	6.563	15.764	-0.497
+D+0.750L+0.750S+H	7.029	16.944	-0.485
+D+0.60W+H	4.673	10.976	-0.545
+D+0.70E+H	4.673	10.976	-0.545
+D+0.750Lr+0.750L+0.450W+H	6.563	15.764	-0.497
+D+0.750L+0.750S+0.450W+H	7.029	16.944	-0.485
+D+0.750L+0.750S+0.5250E+H	7.029	16.944	-0.485
+0.60D+0.60W+0.60H	2.804	6.585	-0.327
+0.60D+0.70E+0.60H	2.804	6.585	-0.327
D Only	4.673	10.976	-0.545
Lr Only	2.520	6.385	0.065
S Only	3.141	7.958	0.081
H Only			

Wood Beam

Lic. #: KW-06010224

File: examples.ec6
Software copyright ENERCALC, INC. 1983-2020, Build:12.20.8.24

D.S. ENGINEERING PC

DESCRIPTION: beam

R8

CODE REFERENCES

Calculations per NDS 2018, IBC 2018, CBC 2019, ASCE 7-16

Load Combination Set : IBC 2018

Material Properties

Analysis Method : Allowable Stress Design
Load Combination IBC 2018

Fb +	2900 psi	E : Modulus of Elasticity	
Fb -	2900 psi	Ebend-xx	2200 ksi
Fc - Prll	2900 psi	Eminbend-xx	1118.19 ksi
Fc - Perp	750 psi		
Fv	290 psi		
Ft	2025 psi	Density	45.07 pcf

Wood Species : iLevel Truss Joist
Wood Grade : Parallam PSL 2.2E

Beam Bracing : Beam is Fully Braced against lateral-torsional buckling

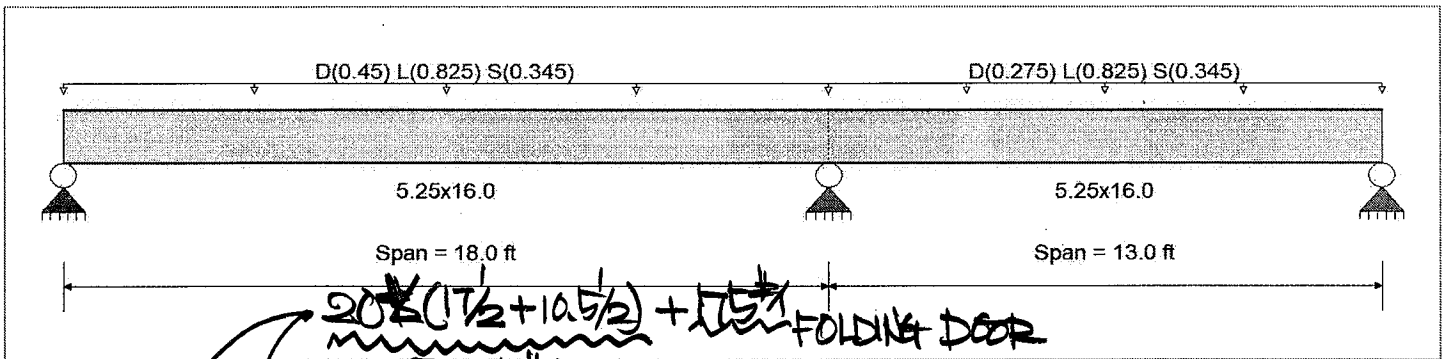

Applied Loads

Service loads entered. Load Factors will be applied for calculations.

Beam self weight calculated and added to loads
Load for Span Number 1

Uniform Load : D = 0.450, L = 0.8250, S = 0.3450, Tributary Width = 1.0 ft

Load for Span Number 2

Uniform Load : D = 0.2750, L = 0.8250, S = 0.3450, Tributary Width = 1.0 ft

DESIGN SUMMARY

Design OK

Maximum Bending Stress Ratio	=	0.774	1	Maximum Shear Stress Ratio	=	0.755	: 1
Section used for this span		5.25x16.0		Section used for this span		5.25x16.0	
fb: Actual	=	2,173.87 psi		fv: Actual	=	219.02 psi	
Fb: Allowable	=	2,808.86 psi		Fv: Allowable	=	290.00 psi	
Load Combination		+D+L+H		Load Combination		+D+L+H	
Location of maximum on span	=	18.000ft		Location of maximum on span	=	16.693 ft	
Span # where maximum occurs	=	Span # 1		Span # where maximum occurs	=	Span # 1	
Maximum Deflection							
Max Downward Transient Deflection		0.264 in	Ratio = 817	>=240			
Max Upward Transient Deflection		-0.017 in	Ratio = 9406	>=240			
Max Downward Total Deflection		0.447 in	Ratio = 483	>=180			
Max Upward Total Deflection		-0.037 in	Ratio = 4168	>=180			

Overall Maximum Deflections

Load Combination	Span	Max. "-" Defl	Location in Span	Load Combination	Max. "+" Defl	Location in Span
+D+0.750L+0.750S+0.5250E+H	1	0.4467	8.145		0.0000	0.000
L Only	2	0.0187	9.006	+D+0.750L+0.750S+0.5250E+H	-0.0374	2.542

Vertical Reactions

Support notation : Far left is #1

Values in KIPS

Load Combination	Support 1	Support 2	Support 3
Overall MAXimum	9.835	25.447	4.410
Overall MINimum	2.484	6.827	1.383
+D+H	3.516	8.082	0.891
+D+L+H	9.457	24.408	4.199
+D+Lr+H	3.516	8.082	0.891
+D+S+H	6.001	14.910	2.275

Wood Beam

File: examples.ec6

Software copyright ENERCALC, INC. 1983-2020, Build:12.20.8.24

Lic. #: KW-06010224

D.S. ENGINEERING PC

DESCRIPTION: beam

R8**Vertical Reactions**

Support notation : Far left is #1

Values in KIPS

Load Combination	Support 1	Support 2	Support 3
+D+0.750Lr+0.750L+H	7.972	20.327	3.372
+D+0.750L+0.750S+H	9.835	25.447	4.410
+D+0.60W+H	3.516	8.082	0.891
+D+0.70E+H	3.516	8.082	0.891
+D+0.750Lr+0.750L+0.450W+H	7.972	20.327	3.372
+D+0.750L+0.750S+0.450W+H	9.835	25.447	4.410
+D+0.750L+0.750S+0.5250E+H	9.835	25.447	4.410
+0.60D+0.60W+0.60H	2.110	4.849	0.535
+0.60D+0.70E+0.60H	2.110	4.849	0.535
D Only	3.516	8.082	0.891
L Only	5.941	16.326	3.308
S Only	2.484	6.827	1.383
H Only			

Wood Beam

File: examples.ec6
 Software copyright ENERCALC, INC. 1983-2020, Build:12.20.8.24
 D.S. ENGINEERING PC

Lic. #: KW-06010224

DESCRIPTION: header (R9)

CODE REFERENCES

Calculations per NDS 2018, IBC 2018, CBC 2019, ASCE 7-16

Load Combination Set : IBC 2018

Material Properties

Analysis Method : Allowable Stress Design	Fb +	900 psi	E : Modulus of Elasticity	
Load Combination IBC 2018	Fb -	900 psi	Ebend-xx	1600ksi
	Fc - Prll	1350 psi	Eminbend - xx	580ksi
Wood Species : Douglas Fir-Larch	Fc - Perp	625 psi		
Wood Grade : No.2	Fv	180 psi		
	Ft	575 psi	Density	31.21 pcf
Beam Bracing : Completely Unbraced				

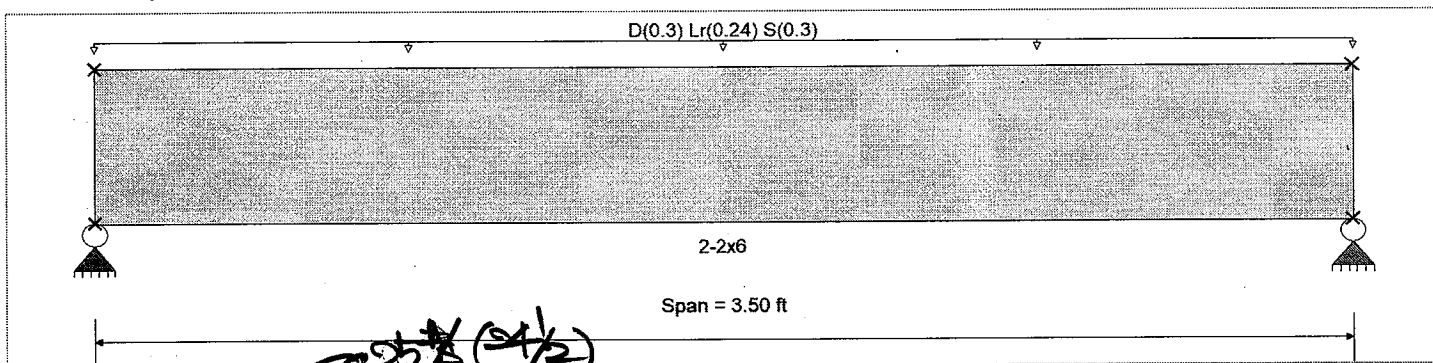

Applied Loads

Service loads entered. Load Factors will be applied for calculations.

Beam self weight calculated and added to loads

Uniform Load : D = 0.30, Lr = 0.240, S = 0.30, Tributary Width = 1.0 ft

DESIGN SUMMARY

Design OK

Maximum Bending Stress Ratio	=	0.548	1	Maximum Shear Stress Ratio	=	0.345	: 1
Section used for this span		2-2x6		Section used for this span		2-2x6	
fb: Actual	=	733.27	psi	fv: Actual	=	71.49	psi
Fb: Allowable	=	1,338.08	psi	Fv: Allowable	=	207.00	psi
Load Combination		+D+S		Load Combination		+D+S	
Location of maximum on span	=	1.750	ft	Location of maximum on span	=	3.053	ft
Span # where maximum occurs	=	Span # 1		Span # where maximum occurs	=	Span # 1	
Maximum Deflection							
Max Downward Transient Deflection		0.015	in	Ratio =		2743	>=360
Max Upward Transient Deflection		0.000	in	Ratio =		0	<360
Max Downward Total Deflection		0.031	in	Ratio =		1363	>=180
Max Upward Total Deflection		0.000	in	Ratio =		0	<180

Overall Maximum Deflections

Load Combination	Span	Max. "+" Defl	Location in Span	Load Combination	Max. "-" Defl	Location in Span
+D+S	1	0.0308	1.763		0.0000	0.000

Vertical Reactions

Support notation : Far left is #1

Values in KIPS

Load Combination	Support 1	Support 2
Overall MAXimum	1.056	1.056
Overall MINimum	0.525	0.525
D Only	0.531	0.531
+D+L	0.531	0.531
+D+Lr	0.951	0.951
+D+S	1.056	1.056
+D+0.750Lr+0.750L	0.846	0.846
+D+0.750L+0.750S	0.925	0.925
+0.60D	0.319	0.319
Lr Only	0.420	0.420

Wood Beam

File: examples.ec6
Software copyright: ENERCALC, INC. 1983-2020, Build: 12.20.8.24
D.S. ENGINEERING PC

Lic. # : KW-06010224

DESCRIPTION: header (R9)

Vertical Reactions

Support notation : Far left is #1

Values in KIPS

Load Combination	Support 1	Support 2
S Only	0.525	0.525

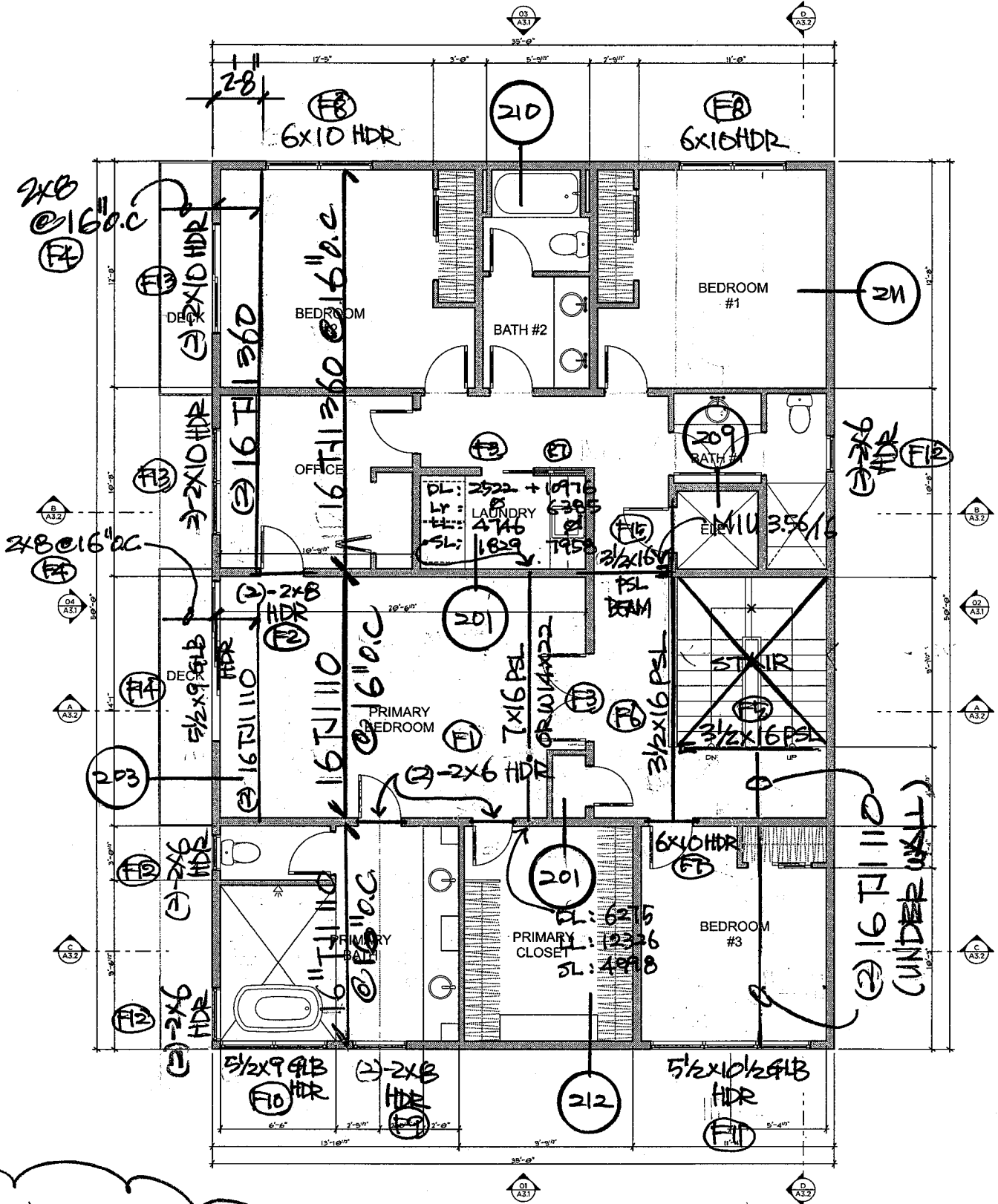

FIRST FLOOR PLAN

SCALE: 1/4" = 1'-0"

2ND FLOOR FRAMING PLAN



FLOOR

DL: 12 PSF
 LL: 40 PSF
 (60 PSF @ DECK)

Level, Floor: Joist
1 piece(s) 16" TJI@ 360 @ 16" OC

Overall Length: 23' 6"

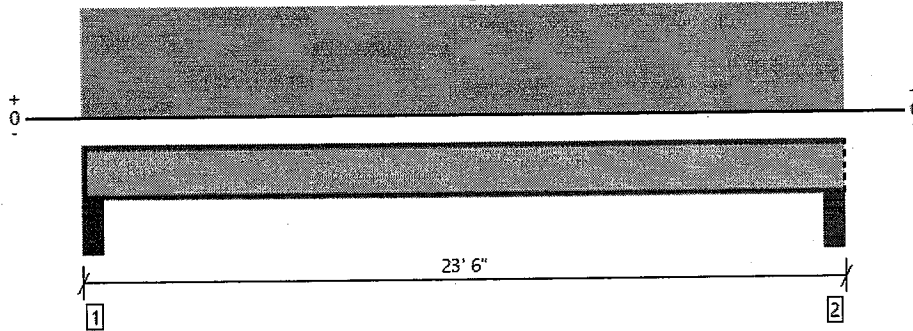

All locations are measured from the outside face of left support (or left cantilever end). All dimensions are horizontal.

Design Results	Actual @ Location	Allowed	Result	IDF	Load: Combination (Pattern)
Member Reaction (lbs)	815 @ 23' 1 1/2"	1505 (3.50")	Passed (54%)	1.00	1.0 D + 1.0 L (All Spans)
Shear (lbs)	783 @ 5 1/2"	2190	Passed (36%)	1.00	1.0 D + 1.0 L (All Spans)
Moment (Ft-lbs)	4486 @ 11' 9"	8405	Passed (53%)	1.00	1.0 D + 1.0 L (All Spans)
Live Load Defl. (in)	0.378 @ 11' 9"	0.569	Passed (L/723)	--	1.0 D + 1.0 L (All Spans)
Total Load Defl. (in)	0.491 @ 11' 9"	1.138	Passed (L/556)	--	1.0 D + 1.0 L (All Spans)
TJ-Pro™ Rating	40	40	Passed	--	--

System : Floor
 Member Type : Joist
 Building Use : Residential
 Building Code : IBC 2018
 Design Methodology : ASD

- Deflection criteria: LL (L/480) and TL (L/240).
- Allowed moment does not reflect the adjustment for the beam stability factor.
- A structural analysis of the deck has not been performed.
- Deflection analysis is based on composite action with a single layer of 23/32" Weyerhaeuser Edge™ Panel (24" Span Rating) that is glued and nailed down.
- Additional considerations for the TJ-Pro™ Rating include: None.

Supports	Bearing Length			Loads to Supports (lbs)			Accessories
	Total	Available	Required	Dead	Floor Live	Total	
1 - Stud wall - HF	5.50"	4.25"	1.75"	188	627	815	1 1/4" Rim Board
2 - Stud wall - HF	5.50"	5.50"	1.75"	188	627	815	Blocking

- Rim Board is assumed to carry all loads applied directly above it, bypassing the member being designed.
- Blocking Panels are assumed to carry no loads applied directly above them and the full load is applied to the member being designed.

Lateral Bracing	Bracing Intervals	Comments
Top Edge (Lu)	5' 3" o/c	
Bottom Edge (Lu)	23' 5" o/c	

- TJI joists are only analyzed using Maximum Allowable bracing solutions.
- Maximum allowable bracing intervals based on applied load.

Vertical Load	Location	Spacing	Dead (0.90)	Floor Live (1.00)	Comments
1 - Uniform (PSF)	0 to 23' 6"	16"	12.0	40.0	Default Load

Weyerhaeuser Notes

Weyerhaeuser warrants that the sizing of its products will be in accordance with Weyerhaeuser product design criteria and published design values. Weyerhaeuser expressly disclaims any other warranties related to the software. Use of this software is not intended to circumvent the need for a design professional as determined by the authority having jurisdiction. The designer of record, builder or framer is responsible to assure that this calculation is compatible with the overall project. Accessories (Rim Board, Blocking Panels and Squash Blocks) are not designed by this software. Products manufactured at Weyerhaeuser facilities are third-party certified to sustainable forestry standards. Weyerhaeuser Engineered Lumber Products have been evaluated by ICC-ES under evaluation reports ESR-1153 and ESR-1387 and/or tested in accordance with applicable ASTM standards. For current code evaluation reports, Weyerhaeuser product literature and installation details refer to www.weyerhaeuser.com/woodproducts/document-library.

The product application, input design loads, dimensions and support information have been provided by ForteWEB Software Operator

ForteWEB Software Operator	Job Notes
dong shin D.S. Engineering PC (425) 338-4776 shin_don@hotmail.com	



2-2

Level, Floor: Joist
1 piece(s) 16" TJI@ 110 @ 16" OC

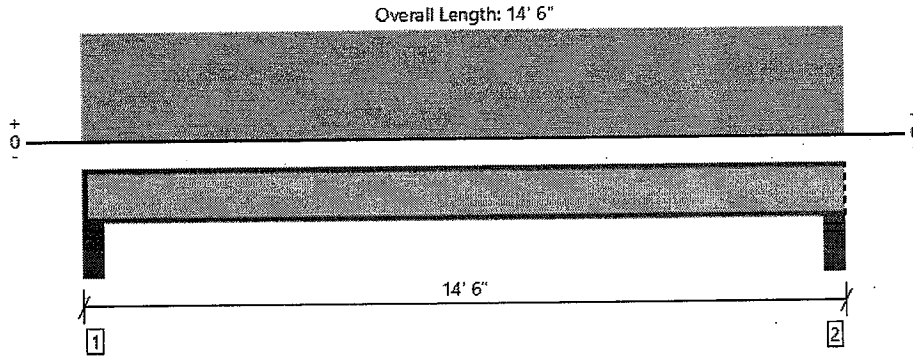

All locations are measured from the outside face of left support (or left cantilever end). All dimensions are horizontal.

Design Results	Actual @ Location	Allowed	Result	LDF	Load: Combination (Pattern)
Member Reaction (lbs)	503 @ 14' 1 1/2"	1375 (3.50")	Passed (37%)	1.00	1.0 D + 1.0 L (All Spans)
Shear (lbs)	471 @ 5 1/2"	2145	Passed (22%)	1.00	1.0 D + 1.0 L (All Spans)
Moment (Ft-lbs)	1639 @ 7' 3"	4280	Passed (38%)	1.00	1.0 D + 1.0 L (All Spans)
Live Load Defl. (in)	0.082 @ 7' 3"	0.344	Passed (L/999+)	--	1.0 D + 1.0 L (All Spans)
Total Load Defl. (in)	0.106 @ 7' 3"	0.688	Passed (L/999+)	--	1.0 D + 1.0 L (All Spans)
TJ-Pro™ Rating	60	40	Passed	--	--

System : Floor
 Member Type : Joist
 Building Use : Residential
 Building Code : IBC 2018
 Design Methodology : ASD

- Deflection criteria: LL (L/480) and TL (L/240).
- Allowed moment does not reflect the adjustment for the beam stability factor.
- A structural analysis of the deck has not been performed.
- Deflection analysis is based on composite action with a single layer of 23/32" Weyerhaeuser Edge™ Panel (24" Span Rating) that is glued and nailed down.
- Additional considerations for the TJ-Pro™ Rating include: None.

Supports	Bearing Length			Loads to Supports (lbs)			Accessories
	Total	Available	Required	Dead	Floor Live	Total	
1 - Stud wall - HF	5.50"	4.25"	1.75"	116	387	503	1 1/4" Rim Board
2 - Stud wall - HF	5.50"	5.50"	1.75"	116	387	503	Blocking

- Rim Board is assumed to carry all loads applied directly above it, bypassing the member being designed.
- Blocking Panels are assumed to carry no loads applied directly above them and the full load is applied to the member being designed.

Lateral Bracing	Bracing Intervals	Comments
Top Edge (Lu)	5' 3" o/c	
Bottom Edge (Lu)	14' 5" o/c	

- TJI joists are only analyzed using Maximum Allowable bracing solutions.
- Maximum allowable bracing intervals based on applied load.

Vertical Load	Location	Spacing	Dead (0.90)	Floor Live (1.00)	Comments
1 - Uniform (PSF)	0 to 14' 6"	16"	12.0	40.0	Default Load

Weyerhaeuser Notes

Weyerhaeuser warrants that the sizing of its products will be in accordance with Weyerhaeuser product design criteria and published design values. Weyerhaeuser expressly disclaims any other warranties related to the software. Use of this software is not intended to circumvent the need for a design professional as determined by the authority having jurisdiction. The designer of record, builder or framer is responsible to assure that this calculation is compatible with the overall project. Accessories (Rim Board, Blocking Panels and Squash Blocks) are not designed by this software. Products manufactured at Weyerhaeuser facilities are third-party certified to sustainable forestry standards. Weyerhaeuser Engineered Lumber Products have been evaluated by ICC-ES under evaluation reports ESR-1153 and ESR-1387 and/or tested in accordance with applicable ASTM standards. For current code evaluation reports, Weyerhaeuser product literature and installation details refer to www.weyerhaeuser.com/woodproducts/document-library.

The product application, input design loads, dimensions and support information have been provided by ForteWEB Software Operator

ForteWEB Software Operator	Job Notes
dong shin D.S. Engineering PC (425) 338-4776 shin_don@hotmail.com	



Level, Floor: Joist

2 piece(s) 11 7/8" TJI® 110 @ 12" OC

Overall Length: 13' 5"

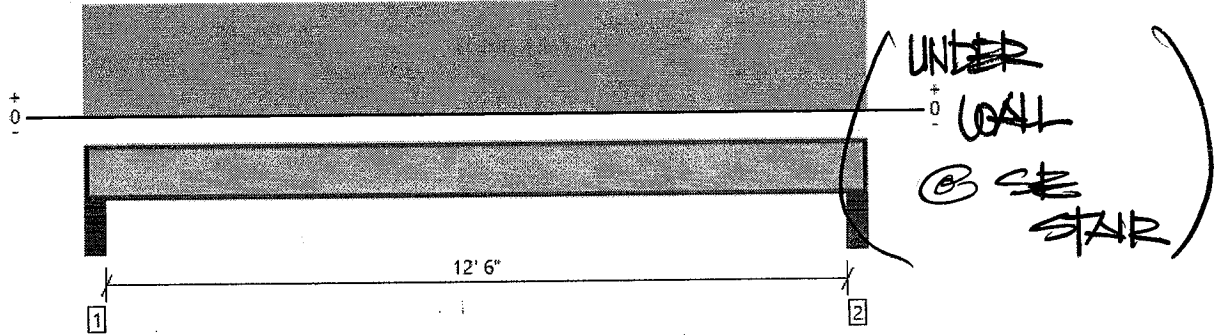

All locations are measured from the outside face of left support (or left cantilever end). All dimensions are horizontal.

Design Results	Actual @ Location	Allowed	Result	LDF	Load: Combination (Pattern)
Member Reaction (lbs)	1783 @ 4 1/2"	2750 (3.50")	Passed (65%)	1.00	1.0 D + 1.0 L (All Spans)
Shear (lbs)	1688 @ 5 1/2"	3120	Passed (54%)	1.00	1.0 D + 1.0 L (All Spans)
Moment (Ft-lbs)	5415 @ 6' 8 1/2"	6320	Passed (86%)	1.00	1.0 D + 1.0 L (All Spans)
Live Load Defl. (in)	0.137 @ 6' 8 1/2"	0.317	Passed (L/999+)	--	1.0 D + 1.0 L (All Spans)
Total Load Defl. (in)	0.309 @ 6' 8 1/2"	0.633	Passed (L/492)	--	1.0 D + 1.0 L (All Spans)
TJ-Pro™ Rating	65	40	Passed	--	--

System : Floor
 Member Type : Joist
 Building Use : Residential
 Building Code : IBC 2018
 Design Methodology : ASD

- Deflection criteria: LL (L/480) and TL (L/240).
- Allowed moment does not reflect the adjustment for the beam stability factor.
- A structural analysis of the deck has not been performed.
- Deflection analysis is based on composite action with a single layer of 23/32" Weyerhaeuser Edge™ Panel (24" Span Rating) that is glued and nailed down.
- Additional considerations for the TJ-Pro™ Rating include: None.

Supports	Bearing Length			Loads to Supports (lbs)					Accessories
	Total	Available	Required	Dead	Floor Live	Roof Live	Snow	Total	
1 - Stud wall - HF	5.50"	4.25"	1.75"	1006	805	134	168	2113	1 1/4" Rim Board
2 - Stud wall - HF	5.50"	4.25"	1.75"	1006	805	134	168	2113	1 1/4" Rim Board

• Rim Board is assumed to carry all loads applied directly above it, bypassing the member being designed.

Lateral Bracing	Bracing Intervals	Comments
Top Edge (Lu)	3' 4" o/c	
Bottom Edge (Lu)	13' 3" o/c	

- TJI joists are only analyzed using Maximum Allowable bracing solutions.
- Maximum allowable bracing intervals based on applied load.

Vertical Load	Location	Spacing	Dead (0.90)	Floor Live (1.00)	Roof Live (non-snow: 1.25)	Snow (1.15)	Comments
1 - Uniform (PLF)	0 to 13' 5"	N/A	150.0	120.0	20.0	25.0	Default Load

Weyerhaeuser Notes
 Weyerhaeuser warrants that the sizing of its products will be in accordance with Weyerhaeuser product design criteria and published design values. Weyerhaeuser expressly disclaims any other warranties related to the software. Use of this software is not intended to circumvent the need for a design professional as determined by the authority having jurisdiction. The designer of record, builder or framer is responsible to assure that this calculation is compatible with the overall project. Accessories (Rim Board, Blocking Panels and Squash Blocks) are not designed by this software. Products manufactured at Weyerhaeuser facilities are third-party certified to sustainable forestry standards. Weyerhaeuser Engineered Lumber Products have been evaluated by ICC-ES under evaluation reports ESR-1153 and ESR-1387 and/or tested in accordance with applicable ASTM standards. For current code evaluation reports, Weyerhaeuser product literature and installation details refer to www.weyerhaeuser.com/woodproducts/document-library.
 The product application, input design loads, dimensions and support information have been provided by ForteWEB Software Operator

ForteWEB Software Operator	Job Notes
dong shin D.S. Engineering PC (425) 338-4776 shin_don@hotmail.com	



4/25/2022 5:47:28 PM UTC
 ForteWEB v3.2, Engine: V8.2.0.17, Data: V8.1.0.16

File Name:
 00369
 2-4 Page 1 / 1

Handwritten notes:
 LKE
 (-) -16 TJI 110
 UNDER WALL @ SE STAR
 20# (2/2) 25# (2/2)
 60# (2)
 20# (2) + 90# WALL

Level, Floor: Joist
1 piece(s) 16" TJI@ 110 @ 12" OC

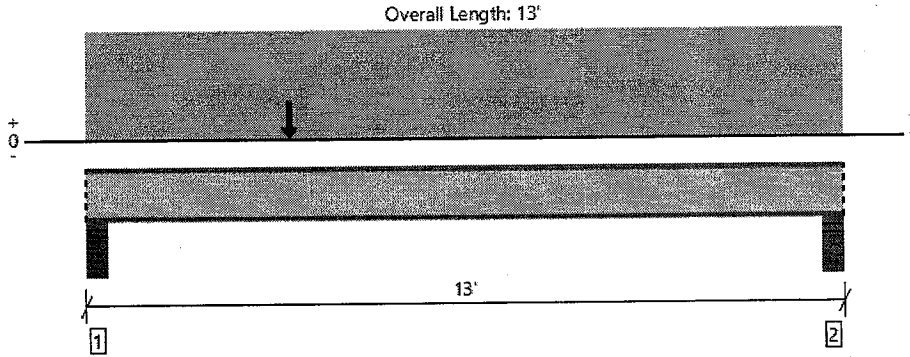

All locations are measured from the outside face of left support (or left cantilever end). All dimensions are horizontal.

Design Results	Actual @ Location	Allowed	Result	IDF	Load: Combination (Pattern)
Member Reaction (lbs)	912 @ 4 1/2"	1375 (3.50")	Passed (66%)	1.00	1.0 D + 1.0 L (All Spans)
Shear (lbs)	888 @ 5 1/2"	2145	Passed (41%)	1.00	1.0 D + 1.0 L (All Spans)
Moment (Ft-lbs)	2534 @ 3' 6"	4280	Passed (59%)	1.00	1.0 D + 1.0 L (All Spans)
Live Load Defl. (in)	0.095 @ 6' 1 3/8"	0.306	Passed (L/999+)	--	1.0 D + 1.0 L (All Spans)
Total Load Defl. (in)	0.128 @ 6' 1 5/16"	0.613	Passed (L/999+)	--	1.0 D + 1.0 L (All Spans)
TJ-Pro™ Rating	65	40	Passed	--	--

System : Floor
 Member Type : Joist
 Building Use : Residential
 Building Code : IBC 2018
 Design Methodology : ASD

- Deflection criteria: LL (L/480) and TL (L/240).
- Allowed moment does not reflect the adjustment for the beam stability factor.
- A structural analysis of the deck has not been performed.
- Deflection analysis is based on composite action with a single layer of 23/32" Weyerhaeuser Edge™ Panel (24" Span Rating) that is glued and nailed down.
- Additional considerations for the TJ-Pro™ Rating include: None.

Supports	Bearing Length			Loads to Supports (lbs)			Accessories
	Total	Available	Required	Dead	Floor Live	Total	
1 - Stud wall - HF	5.50"	5.50"	1.76"	234	677	911	Blocking
2 - Stud wall - HF	5.50"	5.50"	1.75"	132	403	535	Blocking

• Blocking Panels are assumed to carry no loads applied directly above them and the full load is applied to the member being designed.

Lateral Bracing	Bracing Intervals	Comments
Top Edge (Lu)	4' 2" o/c	
Bottom Edge (Lu)	13' o/c	

- TJI joists are only analyzed using Maximum Allowable bracing solutions.
- Maximum allowable bracing intervals based on applied load.

Vertical Loads	Location	Spacing	Dead (0.90)	Floor Live (1.00)	Comments
1 - Uniform (PLF)	0 to 13'	N/A	12.0	40.0	Default Load
2 - Point (lb)	3' 6"	N/A	210	560	

40 #/S (4x14 1/4)
 EXTERIOR STAIR

Weyerhaeuser Notes

Weyerhaeuser warrants that the sizing of its products will be in accordance with Weyerhaeuser product design criteria and published design values. Weyerhaeuser expressly disclaims any other warranties related to the software. Use of this software is not intended to circumvent the need for a design professional as determined by the authority having jurisdiction. The designer of record, builder or framer is responsible to assure that this calculation is compatible with the overall project. Accessories (Rim Board, Blocking Panels and Squash Blocks) are not designed by this software. Products manufactured at Weyerhaeuser facilities are third-party certified to sustainable forestry standards. Weyerhaeuser Engineered Lumber Products have been evaluated by ICC-ES under evaluation reports ESR-1153 and ESR-1387 and/or tested in accordance with applicable ASTM standards. For current code evaluation reports, Weyerhaeuser product literature and installation details refer to www.weyerhaeuser.com/woodproducts/document-library.

The product application, input design loads, dimensions and support information have been provided by ForteWEB Software Operator

15 #/S (4x14 1/4)
 EXTERIOR STAIR

ForteWEB Software Operator	Job Notes
dong shin D.S. Engineering PC (425) 338-4776 shin_don@hotmail.com	



Wood Beam

File: examples.ec6
 Software copyright ENERCALC, INC. 1983-2020, Build:12.20.8.24
 D.S. ENGINEERING PC

Lic. #: KW-06010224

DESCRIPTION: deck

CODE REFERENCES

(WEST)

Calculations per NDS 2018, IBC 2018, CBC 2019, ASCE 7-16
 Load Combination Set : IBC 2018

Material Properties

Analysis Method : Allowable Stress Design	Fb +	900 psi	E : Modulus of Elasticity	
Load Combination IBC 2018	Fb -	900 psi	Ebend-xx	1600ksi
Wood Species : Douglas Fir-Larch	Fc - Prll	1350 psi	Eminbend - xx	580ksi
Wood Grade : No.2	Fc - Perp	625 psi		
Beam Bracing : Beam is Fully Braced against lateral-torsional buckling	Fv	180 psi	Density	31.21 pcf
	Ft	575 psi	Repetitive Member Stress Increase	

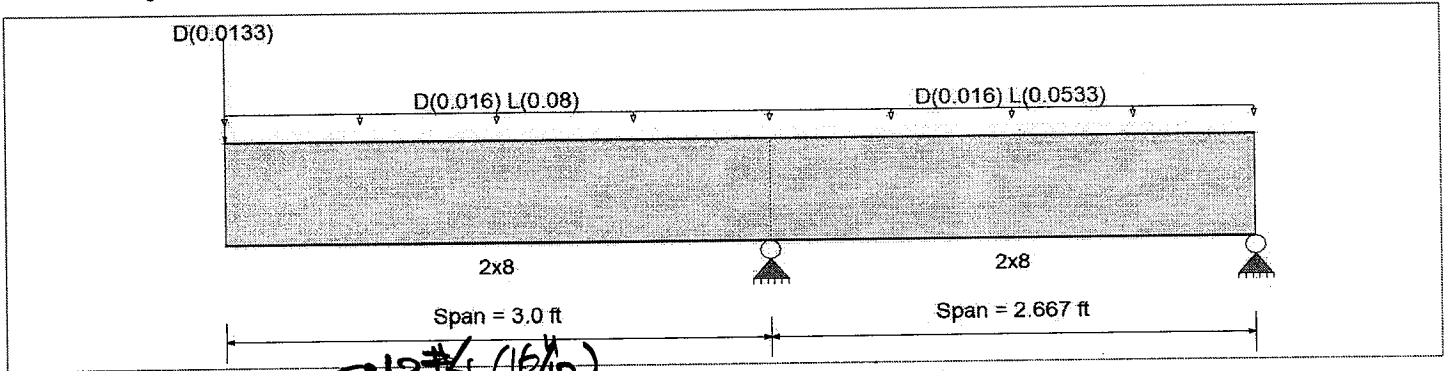

Applied Loads

Service loads entered. Load Factors will be applied for calculations.

Load for Span Number 1
 Uniform Load : D = 0.0160, L = 0.080, Tributary Width = 1.0 ft, (from deck)
 Point Load : D = 0.01330 k @ 0.0 ft, (from guardrail + misc)
 Load for Span Number 2
 Uniform Load : D = 0.0160, L = 0.05330, Tributary Width = 1.0 ft, (from floor)

DESIGN SUMMARY

Design OK

Maximum Bending Stress Ratio	=	0.347 : 1	Maximum Shear Stress Ratio	=	0.186 : 1
Section used for this span	=	2x8	Section used for this span	=	2x8
fb: Actual	=	430.94 psi	fv: Actual	=	33.57 psi
Fb: Allowable	=	1,242.00 psi	Fv: Allowable	=	180.00 psi
Load Combination	=	+D+L+H	Load Combination	=	+D+L+H
Location of maximum on span	=	3.000ft	Location of maximum on span	=	2.397 ft
Span # where maximum occurs	=	Span # 1	Span # where maximum occurs	=	Span # 1
Maximum Deflection					
Max Downward Transient Deflection		0.037 in Ratio = 1928 >=240			
Max Upward Transient Deflection		-0.003 in Ratio = 10651 >=240			
Max Downward Total Deflection		0.050 in Ratio = 1450 >=180			
Max Upward Total Deflection		-0.004 in Ratio = 8109 >=180			

Overall Maximum Deflections

Load Combination	Span	Max. "-" Defl	Location in Span	Load Combination	Max. "+" Defl	Location in Span
+D+L+H	1	0.0497	0.000		0.0000	0.000
	2	0.0000	0.000	+D+L+H	-0.0039	1.073

Vertical Reactions

Support notation : Far left is #1

Values in KIPS

Load Combination	Support 1	Support 2	Support 3
Overall MAXimum		0.571	-0.085
Overall MINimum		0.446	-0.021
+D+H		0.125	-0.021
+D+L+H		0.571	-0.085
+D+Lr+H		0.125	-0.021
+D+S+H		0.125	-0.021

Wood Beam

File: examples.ec6
Software copyright ENERCALC, INC. 1983-2020, Build:12:20:8:24
D.S. ENGINEERING PC

Lic. #: KW-06010224

DESCRIPTION: deck

Vertical Reactions

Support notation : Far left is #1

Values in KIPS

Load Combination	Support 1	Support 2	Support 3
+D+0.750Lr+0.750L+H		0.459	-0.069
+D+0.750L+0.750S+H		0.459	-0.069
+D+0.60W+H		0.125	-0.021
+D+0.70E+H		0.125	-0.021
+D+0.750Lr+0.750L+0.450W+H		0.459	-0.069
+D+0.750L+0.750S+0.450W+H		0.459	-0.069
+D+0.750L+0.750S+0.5250E+H		0.459	-0.069
+0.60D+0.60W+0.60H		0.075	-0.012
+0.60D+0.70E+0.60H		0.075	-0.012
D Only		0.125	-0.021
L Only		0.446	-0.064
H Only			

Wood Beam

Lic. #: KW-06010224

File: examples.ec6
 Software copyright ENERCALC, INC. 1983-2020, Build:12.20.8.24
 D.S. ENGINEERING PC

DESCRIPTION: header

CODE REFERENCES

(F1)

Calculations per NDS 2018, IBC 2018, CBC 2019, ASCE 7-16

Load Combination Set : IBC 2018

Material Properties

Analysis Method : Allowable Stress Design
 Load Combination IBC 2018

Fb +	900 psi	E : Modulus of Elasticity	
Fb -	900 psi	Ebend- xx	1600ksi
Fc - Prll	1350 psi	Eminbend - xx	580ksi
Fc - Perp	625 psi		
Fv	180 psi		
Ft	575 psi	Density	31.21 pcf

Wood Species : Douglas Fir-Larch
 Wood Grade : No.2

Beam Bracing : Completely Unbraced

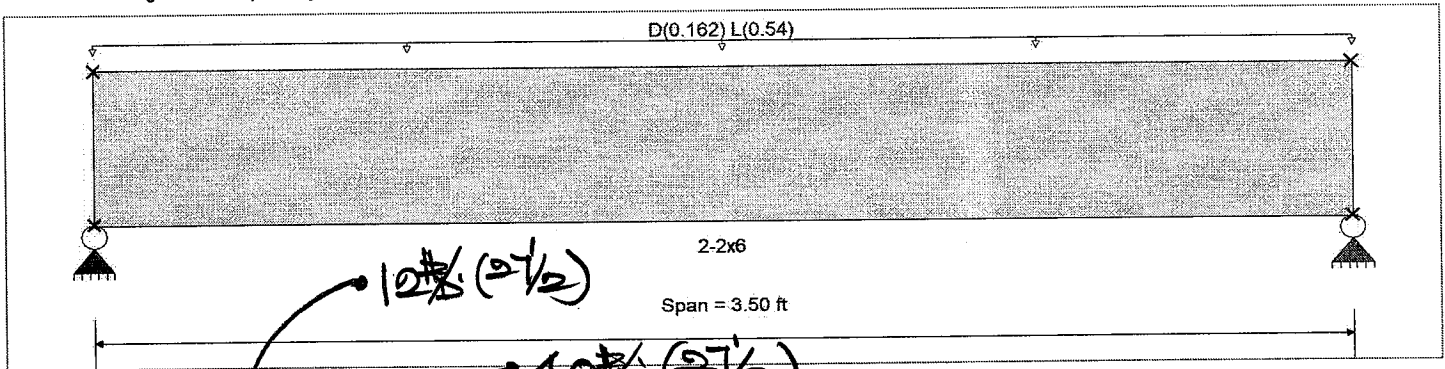

Applied Loads

Beam self weight calculated and added to loads

Uniform Load : D = 0.1620, L = 0.540, Tributary Width = 1.0 ft

Service loads entered. Load Factors will be applied for calculations.

DESIGN SUMMARY

Design OK

Maximum Bending Stress Ratio	=	0.736	1	Maximum Shear Stress Ratio	=	0.464	: 1
Section used for this span		2-2x6		Section used for this span		2-2x6	
fb: Actual	=	857.19psi		fv: Actual	=	83.57 psi	
Fb: Allowable	=	1,164.46psi		Fv: Allowable	=	180.00 psi	
Load Combination		+D+L+H		Load Combination		+D+L+H	
Location of maximum on span	=	1.750ft		Location of maximum on span	=	3.053 ft	
Span # where maximum occurs	=	Span # 1		Span # where maximum occurs	=	Span # 1	
Maximum Deflection							
Max Downward Transient Deflection		0.028 in	Ratio =	1524	>=	240	
Max Upward Transient Deflection		0.000 in	Ratio =	0	<	240	
Max Downward Total Deflection		0.036 in	Ratio =	1166	>=	180	
Max Upward Total Deflection		0.000 in	Ratio =	0	<	180	

Overall Maximum Deflections

Load Combination	Span	Max. "-" Defl	Location in Span	Load Combination	Max. "+" Defl	Location in Span
+D+L+H	1	0.0360	1.763		0.0000	0.000

Vertical Reactions

Support notation : Far left is #1

Values in KIPS

Load Combination	Support 1	Support 2
Overall MAXimum	1.235	1.235
Overall MINimum	0.945	0.945
+D+H	0.290	0.290
+D+L+H	1.235	1.235
+D+Lr+H	0.290	0.290
+D+S+H	0.290	0.290
+D+0.750Lr+0.750L+H	0.999	0.999
+D+0.750L+0.750S+H	0.999	0.999
+D+0.60W+H	0.290	0.290
+D+0.70E+H	0.290	0.290

Wood Beam

File: examples.ec6

Software copyright ENERCALC, INC. 1983-2020. Build: 12.20.8.24

D.S. ENGINEERING PC

Lic. #: KW-06010224

DESCRIPTION: header



Support notation : Far left is #1

Values in KIPS

Load Combination	Support 1	Support 2
+D+0.750Lr+0.750L+0.450W+H	0.999	0.999
+D+0.750L+0.750S+0.450W+H	0.999	0.999
+D+0.750L+0.750S+0.5250E+H	0.999	0.999
+0.60D+0.60W+0.60H	0.174	0.174
+0.60D+0.70E+0.60H	0.174	0.174
D Only	0.290	0.290
L Only	0.945	0.945
H Only		

Wood Beam

File: examples.ecb
 Software copyright ENERCALC, INC. 1983-2020, Build:12.20.8.24
 D.S. ENGINEERING PC

Lic. #: KW-06010224

DESCRIPTION: header (F2)

CODE REFERENCES

Calculations per NDS 2018, IBC 2018, CBC 2019, ASCE 7-16
 Load Combination Set : IBC 2018

Material Properties

Analysis Method : Allowable Stress Design	Fb +	900 psi	E : Modulus of Elasticity	
Load Combination IBC 2018	Fb -	900 psi	Ebend- xx	1600 ksi
	Fc - Prll	1350 psi	Eminbend - xx	580 ksi
Wood Species : Douglas Fir-Larch	Fc - Perp	625 psi		
Wood Grade : No.2	Fv	180 psi		
	Ft	575 psi	Density	31.21 pcf
Beam Bracing : Completely Unbraced				

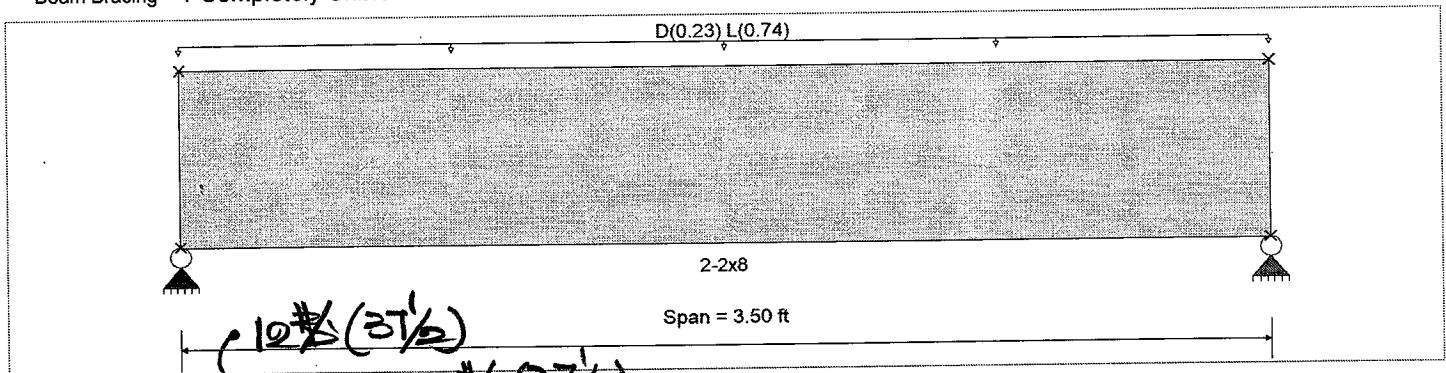

Applied Loads

Service loads entered. Load Factors will be applied for calculations.

Beam self weight calculated and added to loads
 Uniform Load : D = 0.230, L = 0.740, Tributary Width = 1.0 ft

DESIGN SUMMARY

Design OK

Maximum Bending Stress Ratio	=	0.635	1	Maximum Shear Stress Ratio	=	0.429	: 1
Section used for this span		2-2x8		Section used for this span		2-2x8	
fb: Actual	=	681.49psi		fv: Actual	=	77.28 psi	
Fb: Allowable	=	1,073.53psi		Fv: Allowable	=	180.00 psi	
Load Combination		+D+L		Load Combination		+D+L	
Location of maximum on span	=	1.750ft		Location of maximum on span	=	2.900 ft	
Span # where maximum occurs	=	Span # 1		Span # where maximum occurs	=	Span # 1	
Maximum Deflection							
Max Downward Transient Deflection		0.016 in	Ratio = 2547				>=360
Max Upward Transient Deflection		0.000 in	Ratio = 0				<360
Max Downward Total Deflection		0.022 in	Ratio = 1934				>=180
Max Upward Total Deflection		0.000 in	Ratio = 0				<180

Overall Maximum Deflections

Load Combination	Span	Max. "-" Defl	Location in Span	Load Combination	Max. "+" Defl	Location in Span
+D+L	1	0.0217	1.763		0.0000	0.000

Vertical Reactions

Support notation : Far left is #1

Values in KIPS

Load Combination	Support 1	Support 2
Overall MAXimum	1.706	1.706
Overall MINimum	1.295	1.295
D Only	0.411	0.411
+D+L	1.706	1.706
+D+0.750L	1.382	1.382
+0.60D	0.246	0.246
L Only	1.295	1.295

Wood Beam

Project File: ENERCALC_20

LIC#: KW-06015335, Build:20.22.4.26

D.S. ENGINEERING PC

(c) ENERCALC INC 1983-2022

DESCRIPTION: beam (F3)

CODE REFERENCES

Calculations per NDS 2018, IBC 2018, CBC 2019, ASCE 7-16
Load Combination Set : IBC 2018

Material Properties

Analysis Method : Allowable Stress Design	Fb +	2900 psi	<i>E</i> : Modulus of Elasticity
Load Combination : IBC 2018	Fb -	2900 psi	Ebend- xx 2200ksi
	Fc - Prll	2900 psi	Eminbend - xx 1118.19ksi
Wood Species : iLevel Truss Joist	Fc - Perp	750 psi	
Wood Grade : Parallam PSL 2.2E	Fv	290 psi	
	Ft	2025 psi	Density 45.07 pcf
Beam Bracing : Beam is Fully Braced against lateral-torsional buckling			

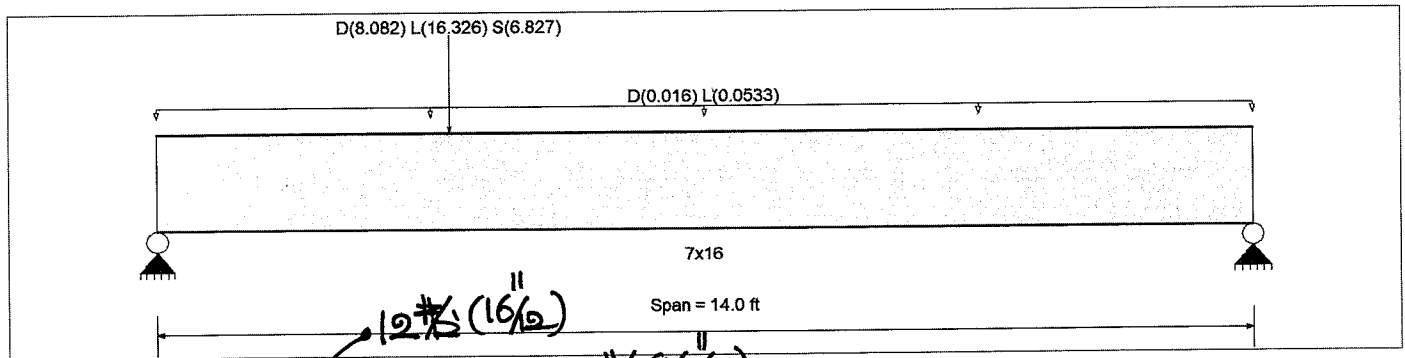

Applied Loads

Beam self weight calculated and added to loading
Uniform Load : D = 0.0160, L = 0.05330 , Tributary Width = 1.0 ft
Point Load : D = 8.082, L = 16.326, S = 6.827 k @ 3.750 ft, (from 6x6 post with (R7))

DESIGN SUMMARY

Design OK

Maximum Bending Stress Ratio =	0.954	1	Maximum Shear Stress Ratio =	0.853	1
Section used for this span	7x16		Section used for this span	7x16	
fb: Actual =	2,765.34	psi	fv: Actual =	247.26	psi
Fb: Allowable =	2,900.00	psi	Fv: Allowable =	290.00	psi
Load Combination =	+D+L		Load Combination =	+D+L	
Location of maximum on span =	3.781	ft	Location of maximum on span =	0.000 ft	
Span # where maximum occurs =	Span # 1		Span # where maximum occurs =	Span # 1	
Maximum Deflection					
Max Downward Transient Deflection	0.237	in	Ratio =	710	>=360
Max Upward Transient Deflection	0	in	Ratio =	0	<360
Max Downward Total Deflection	0.370	in	Ratio =	454	>=240
Max Upward Total Deflection	0	in	Ratio =	0	<240
			Span: 1 : L Only		
			Span: 1 : +D+0.750L+0.750S		

Overall Maximum Deflections

Load Combination	Span	Max. "-" Defl	Location in Span	Load Combination	Max. "+" Defl	Location in Span
+D+0.750L+0.750S	1	0.3700	6.285		0.0000	0.000

Vertical Reactions

Support notation : Far left is #1

Values in KIPS

Load Combination	Support 1	Support 2
Overall MAXimum	19.268	7.453
Overall MINimum	4.998	1.829
D Only	6.275	2.522
+D+L	18.601	7.268
+D+S	11.273	4.351
+D+0.750L	15.519	6.082
+D+0.750L+0.750S	19.268	7.453
+0.60D	3.765	1.513
L Only	12.326	4.746

Wood Beam

Project File: ENERCALC_20

LIC# : KW-06015335, Build:20.22.4.26

D.S. ENGINEERING PC

(c) ENERCALC INC 1983-2022

DESCRIPTION: beam (F3)**Vertical Reactions**

Support notation : Far left is #1

Values in KIPS

Load Combination	Support 1	Support 2
S Only	4.998	1.829

Wood Column

Lic. #: KW-06010224

DESCRIPTION: 6x8 post under 7x17 PSL

Code References

Calculations per NDS 2018, IBC 2018, CBC 2019, ASCE 7-16
Load Combinations Used : IBC 2018

General Information

Analysis Method :	Allowable Stress Design			Wood Section Name	6x8		
End Fixities	Top & Bottom Pinned			Wood Grading/Manuf.	Graded Lumber		
Overall Column Height	9 ft			Wood Member Type	Sawn		
<i>(Used for non-slender calculations)</i>							
Wood Species	Douglas Fir-Larch			Exact Width	5.50 in	Allow Stress Modification Factors	
Wood Grade	No.2			Exact Depth	7.50 in	Cf or Cv for Bending	1.0
Fb +	750.0 psi	Fv	170.0 psi	Area	41.250 in ²	Cf or Cv for Compression	1.0
Fb -	750.0 psi	Ft	475.0 psi	Ix	193.359 in ⁴	Cf or Cv for Tension	1.0
Fc - Prll	700.0 psi	Density	31.210 pcf	Iy	103.984 in ⁴	Cm : Wet Use Factor	1.0
Fc - Perp	625.0 psi					Ct : Temperature Factor	1.0
E : Modulus of Elasticity . . .	x-x Bending	y-y Bending	Axial			Cfu : Flat Use Factor	1.0
	Basic	1,300.0	1,300.0	1,300.0 ksi		Kf : Built-up columns	1.0 <small>NDS 15.3.2</small>
	Minimum	470.0	470.0			Use Cr : Repetitive ?	No
Brace condition for deflection (buckling) along columns :							
				X-X (width) axis :	Unbraced Length for buckling ABOUT Y-Y Axis = ft, K = 1.0		
				Y-Y (depth) axis :	Unbraced Length for buckling ABOUT X-X Axis = 8 ft, K = 1.0		

Service loads entered. Load Factors will be applied for calculations.

Applied Loads

Column self weight included : 80.463 lbs * Dead Load Factor
AXIAL LOADS . . .
from <R7>: Axial Load at 9.0 ft, D = 10.976, Lr = 6.385, S = 7.958 k
from (F3): Axial Load at 9.0 ft, D = 2.522, L = 4.746, S = 1.829 k

DESIGN SUMMARY

Bending & Shear Check Results

PASS Max. Axial+Bending Stress Ratio =	0.8043 : 1
Load Combination	+D+0.750L+0.750S
Governing NDS Formula	Comp Only, fc/Fc'
Location of max.above base	0.0 ft
At maximum location values are . . .	
Applied Axial	24.478 k
Applied Mx	0.0 k-ft
Applied My	0.0 k-ft
Fc : Allowable	737.81 psi
PASS Maximum Shear Stress Ratio =	0.0 : 1
Load Combination	+0.4775D
Location of max.above base	9.0 ft
Applied Design Shear	0.0 psi
Allowable Shear	272.0 psi

Maximum SERVICE Lateral Load Reactions . .

Top along Y-Y	0.0 k	Bottom along Y-Y	0.0 k
Top along X-X	0.0 k	Bottom along X-X	0.0 k

Maximum SERVICE Load Lateral Deflections . . .

Along Y-Y	0.0 in	at	0.0 ft	above base
for load combination : n/a				
Along X-X	0.0 in	at	0.0 ft	above base
for load combination : n/a				

Other Factors used to calculate allowable stresses . . .

Bending Compression Tension

Load Combination Results

Load Combination	C _D	C _P	Maximum Axial + Bending Stress Ratios			Maximum Shear Ratios		
			Stress Ratio	Status	Location	Stress Ratio	Status	Location
D Only	0.900	0.937	0.5574	PASS	0.0 ft	0.0	PASS	9.0 ft
+D+L	1.000	0.929	0.6830	PASS	0.0 ft	0.0	PASS	9.0 ft
+D+Lr	1.250	0.908	0.6093	PASS	0.0 ft	0.0	PASS	9.0 ft
+D+S	1.150	0.917	0.7677	PASS	0.0 ft	0.0	PASS	9.0 ft
+D+0.750Lr+0.750L	1.250	0.908	0.6692	PASS	0.0 ft	0.0	PASS	9.0 ft
+D+0.750L+0.750S	1.150	0.917	0.8043	PASS	0.0 ft	0.0	PASS	9.0 ft
+1.123D	1.600	0.875	0.3769	PASS	0.0 ft	0.0	PASS	9.0 ft
+1.092D+0.750L+0.750S	1.600	0.875	0.6361	PASS	0.0 ft	0.0	PASS	9.0 ft
+0.60D	1.600	0.875	0.2014	PASS	0.0 ft	0.0	PASS	9.0 ft
+0.4775D	1.600	0.875	0.1603	PASS	0.0 ft	0.0	PASS	9.0 ft

Steel Beam

Project File: ENERCALC_20

LIC#: KW-06015335, Build:20.22.4.26

D.S. ENGINEERING PC

(c) ENERCALC INC 1983-2022

DESCRIPTION: beam (F3) alt

CODE REFERENCES

Calculations per AISC 360-16, IBC 2018, CBC 2019, ASCE 7-16
 Load Combination Set : IBC 2018

Material Properties

Analysis Method : Allowable Strength Design
 Beam Bracing : Beam is Fully Braced against lateral-torsional buckling
 Bending Axis : Major Axis Bending

Fy : Steel Yield : 50.0 ksi
 E : Modulus : 29,000.0 ksi

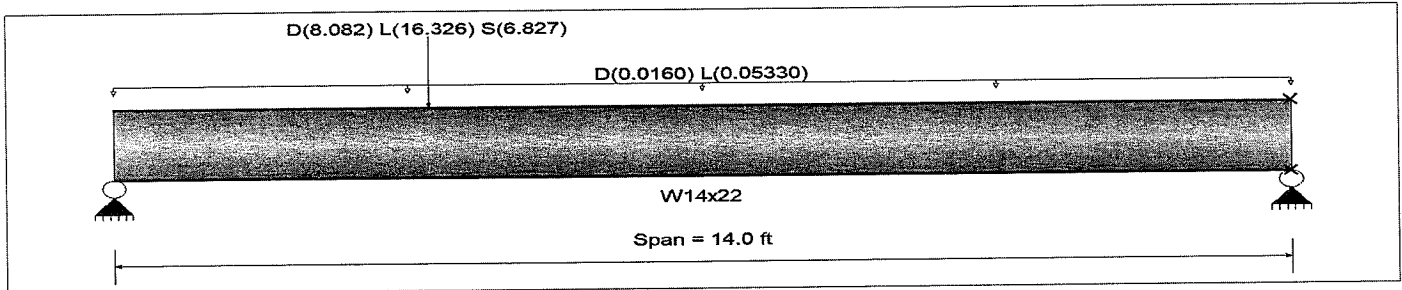

Applied Loads

Service loads entered. Load Factors will be applied for calculations.

Beam self weight calculated and added to loading
 Uniform Load : D = 0.0160, L = 0.05330 k/ft, Tributary Width = 1.0 ft

Point Load : D = 8.082, L = 16.326, S = 6.827 k @ 3.750 ft, (from 6x6 post with (R7))

DESIGN SUMMARY

Design OK

Maximum Bending Stress Ratio =	0.861 : 1	Maximum Shear Stress Ratio =	0.304 : 1
Section used for this span	W14x22	Section used for this span	W14x22
Ma : Applied	71.298 k-ft	Va : Applied	19.176 k
Mn / Omega : Allowable	82.834 k-ft	Vn/Omega : Allowable	63.020 k
Load Combination	+D+0.750L+0.750S	Load Combination	+D+0.750L+0.750S
Span # where maximum occurs	Span # 1	Location of maximum on span	0.000 ft
Span # where maximum occurs	Span # 1	Span # where maximum occurs	Span # 1
Maximum Deflection			
Max Downward Transient Deflection	0.215 in Ratio = 780	>=360	
Max Upward Transient Deflection	0.000 in Ratio = 0	<360	Span: 1 : L Only
Max Downward Total Deflection	0.335 in Ratio = 502	>=240	Span: 1 : +D+0.750L+0.750S
Max Upward Total Deflection	0.000 in Ratio = 0	<240.0	

Maximum Forces & Stresses for Load Combinations

Load Combination	Segment Length	Span #	Max Stress Ratios		Summary of Moment Values						Summary of Shear Values			
			M	V	Mmax +	Mmax -	Ma Max	Mnx	Mnx/Omega	Cb	Rm	Va Max	Vnx/Vnx/Omega	
D Only														
Dsgn. L = 14.00 ft	14.00 ft	1	0.276	0.098	22.90		22.90	138.33	82.83	1.00	1.00	6.18	94.53	63.02
+D+L														
Dsgn. L = 14.00 ft	14.00 ft	1	0.829	0.294	68.71		68.71	138.33	82.83	1.00	1.00	18.51	94.53	63.02
+D+S														
Dsgn. L = 14.00 ft	14.00 ft	1	0.503	0.177	41.62		41.62	138.33	82.83	1.00	1.00	11.18	94.53	63.02
+D+0.750L														
Dsgn. L = 14.00 ft	14.00 ft	1	0.691	0.245	57.25		57.25	138.33	82.83	1.00	1.00	15.43	94.53	63.02
+D+0.750L+0.750S														
Dsgn. L = 14.00 ft	14.00 ft	1	0.861	0.304	71.30		71.30	138.33	82.83	1.00	1.00	19.18	94.53	63.02
+0.60D														
Dsgn. L = 14.00 ft	14.00 ft	1	0.166	0.059	13.74		13.74	138.33	82.83	1.00	1.00	3.71	94.53	63.02

Overall Maximum Deflections

Load Combination	Span	Max. "-" Defl	Location in Span	Load Combination	Max. "+" Defl	Location in Span
+D+0.750L+0.750S	1	0.3346	6.240		0.0000	0.000

Vertical Reactions

Load Combination	Support 1	Support 2
Overall MAXimum	19.176	7.362

Support notation : Far left is #

Values in KIPS

00379

2-14

Steel Beam

Project File: ENERCALC_20

LIC#: KW-06015335, Build:20.22.4.26

D.S. ENGINEERING PC

(c) ENERCALC INC 1983-2022

DESCRIPTION: beam (F3) alt**Vertical Reactions**

Support notation : Far left is #

Values in KIPS

Load Combination	Support 1	Support 2
Overall MINimum	3.710	1.458
D Only	6.183	2.431
+D+L	18.509	7.177
+D+S	11.182	4.259
+D+0.750L	15.428	5.990
+D+0.750L+0.750S	19.176	7.362
+0.60D	3.710	1.458
L Only	12.326	4.746
S Only	4.998	1.829

Steel Section Properties : W14x22

Depth	=	13.700 in	I xx	=	199.00 in ⁴	J	=	0.208 in ⁴
Web Thick	=	0.230 in	S xx	=	29.00 in ³	Cw	=	314.00 in ⁶
Flange Width	=	5.000 in	R xx	=	5.540 in			
Flange Thick	=	0.335 in	Zx	=	33.200 in ³			
Area	=	6.490 in ²	I yy	=	7.000 in ⁴			
Weight	=	22.000 plf	S yy	=	2.800 in ³	Wno	=	16.700 in ²
Kdesign	=	0.735 in	R yy	=	1.040 in	Sw	=	7.000 in ⁴
K1	=	0.750 in	Zy	=	4.390 in ³	Qf	=	5.340 in ³
rts	=	1.270 in				Qw	=	16.100 in ³
Ycg	=	6.850 in						

Wood Beam

File: examples.ec6
 Software copyright ENERCALC, INC. 1983-2020, Build:12.20.8.24
 D.S. ENGINEERING PC

Lic. #: KW-06010224

DESCRIPTION: deck

F4

CODE REFERENCES

Calculations per NDS 2018, IBC 2018, CBC 2019, ASCE 7-16

Load Combination Set : IBC 2018

Material Properties

Analysis Method : Allowable Stress Design
 Load Combination IBC 2018

Fb + 900.0 psi
 Fb - 900.0 psi
 Fc - Prll 1,350.0 psi
 Fc - Perp 625.0 psi
 Fv 180.0 psi
 Ft 575.0 psi

E : Modulus of Elasticity

Ebend-xx 1,600.0ksi
 Eminbend - xx 580.0ksi

Wood Species : Douglas Fir-Larch
 Wood Grade : No.2

Beam Bracing : Completely Unbraced

Density 31.210pcf
 Repetitive Member Stress Increase

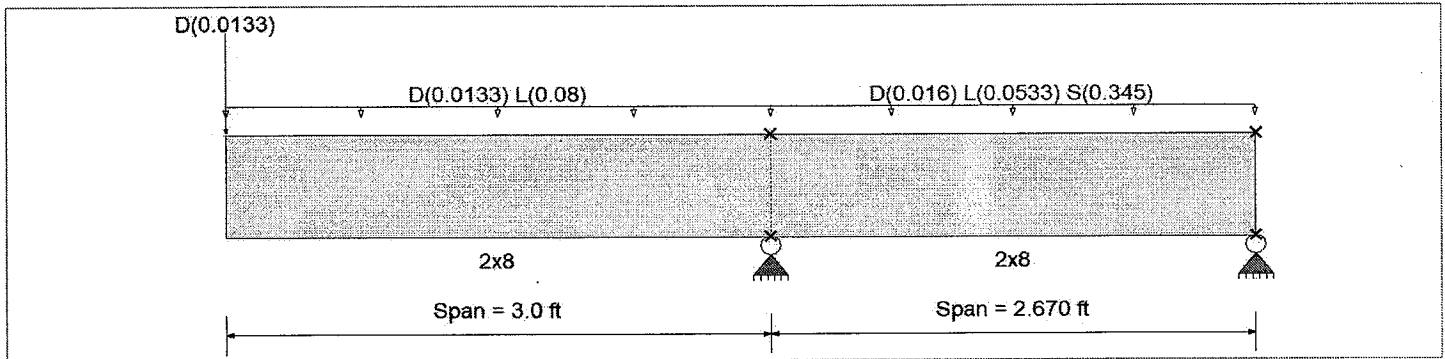

Applied Loads

Service loads entered. Load Factors will be applied for calculations.

Load for Span Number 1

Uniform Load : D = 0.01330, L = 0.080, Tributary Width = 1.0 ft

Point Load : D = 0.01330 k @ 0.0 ft, (guardrail & misc)

Load for Span Number 2

Uniform Load : D = 0.0160, L = 0.05330, S = 0.3450, Tributary Width = 1.0 ft

DESIGN SUMMARY

Design OK

Maximum Bending Stress Ratio	=	0.350	1	Maximum Shear Stress Ratio	=	0.247	1
Section used for this span		2x8		Section used for this span		2x8	
fb: Actual	=	419.84 psi		fv: Actual	=	51.15 psi	
Fb: Allowable	=	1,199.96 psi		Fv: Allowable	=	207.00 psi	
Load Combination		+D+L+H		Load Combination		+D+0.750L+0.750S+H	
Location of maximum on span	=	3.000ft		Location of maximum on span	=	3.000 ft	
Span # where maximum occurs	=	Span # 1		Span # where maximum occurs	=	Span # 1	
Maximum Deflection							
Max Downward Transient Deflection		0.037 in	Ratio =	1926	>=	240	
Max Upward Transient Deflection		-0.019 in	Ratio =	3868	>=	240	
Max Downward Total Deflection		0.048 in	Ratio =	1490	>=	180	
Max Upward Total Deflection		-0.004 in	Ratio =	8374	>=	180	

Overall Maximum Deflections

Load Combination	Span	Max. "-" Defl	Location in Span	Load Combination	Max. "+" Defl	Location in Span
+D+L+H	1	0.0483	0.000		0.0000	0.000
S Only	2	0.0052	1.342	+D+L+H	-0.0027	0.462

Vertical Reactions

Support notation : Far left is #1

Values in KIPS

Load Combination	Support 1	Support 2	Support 3
Overall MAXimum		0.792	0.461
Overall MINimum		0.461	0.461
+D+H		0.112	-0.016
+D+L+H		0.558	-0.080
+D+Lr+H		0.112	-0.016
+D+S+H		0.572	0.445

Wood BeamFile: examples.ec6
Software copyright ENERCALC, INC. 1983-2020, Build:12.20.8.24
D.S. ENGINEERING PC

Lic. #: KW-06010224

DESCRIPTION: deck

**Vertical Reactions**

Support notation : Far left is #1

Values in KIPS

Load Combination	Support 1	Support 2	Support 3
+D+0.750Lr+0.750L+H		0.446	-0.064
+D+0.750L+0.750S+H		0.792	0.282
+D+0.60W+H		0.112	-0.016
+D+0.70E+H		0.112	-0.016
+D+0.750Lr+0.750L+0.450W+H		0.446	-0.064
+D+0.750L+0.750S+0.450W+H		0.792	0.282
+D+0.750L+0.750S+0.5250E+H		0.792	0.282
+0.60D+0.60W+0.60H		0.067	-0.010
+0.60D+0.70E+0.60H		0.067	-0.010
D Only		0.112	-0.016
L Only		0.446	-0.064
S Only		0.461	0.461
H Only			

Wood Beam

Lic. #: KW-06010224

DESCRIPTION: beam

(STAIR) (F5)

CODE REFERENCES

Calculations per NDS 2018, IBC 2018, CBC 2019, ASCE 7-16

Load Combination Set : IBC 2018

Material Properties

Analysis Method : Allowable Stress Design	Fb +	2900 psi	E : Modulus of Elasticity	
Load Combination IBC 2018	Fb -	2900 psi	Ebend- xx	2200 ksi
	Fc- Prll	2900 psi	Eminbend - xx	1118.19 ksi
Wood Species : iLevel Truss Joist	Fc- Perp	750 psi		
Wood Grade : Parallam PSL 2.2E	Fv	290 psi		
	Ft	2025 psi	Density	45.07 pcf
Beam Bracing : Beam is Fully Braced against lateral-torsional buckling				

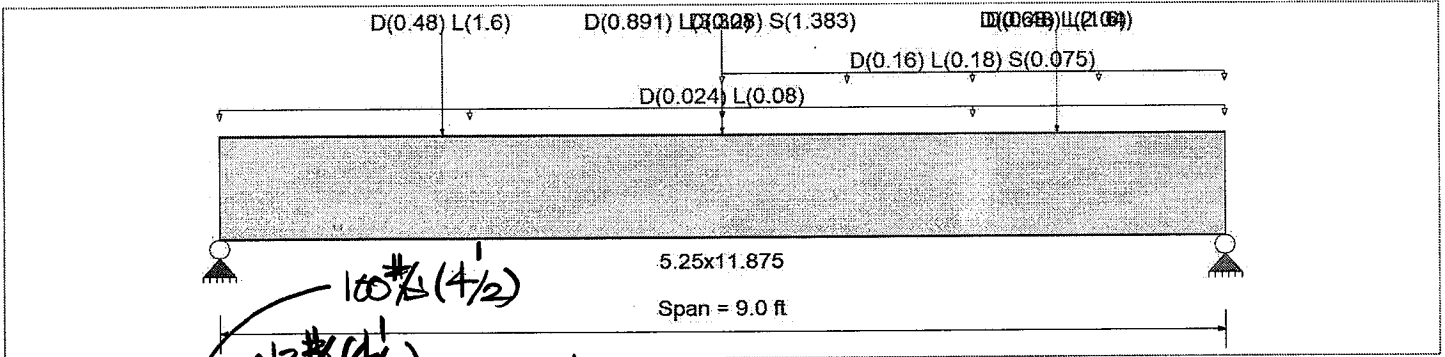

Applied Loads

Service loads entered. Load Factors will be applied for calculations.

Beam self weight calculated and added to loads

- Uniform Load : D = 0.0240, L = 0.080, Tributary Width = 1.0 ft, (from 2nd floor)
- Point Load : D = 0.480, L = 1.60 k @ 2.0 ft, (from stair) ← 12# x 4' x 10' & 40# x 4' x 10'
- Point Load : D = 0.20 k @ 4.50 ft, (from wall wt)
- Point Load : D = 0.8910, L = 3.308, S = 1.383 k @ 4.50 ft, (from 5.25x16 PSL)
- Point Load : D = 0.680, L = 2.040 k @ 7.50 ft, (from stair (roof)) ← 20# x 17' x 4 1/2' & 60# x 17' x 4 1/2'
- Point Load : D = 0.480, L = 1.60 k @ 7.50 ft, (from stair)
- Uniform Load : D = 0.160, L = 0.180, S = 0.0750 k/ft, Extent = 4.50 → 9.0 ft, Tributary Width = 1.0 ft, (from wall (roof))

DESIGN SUMMARY

Maximum Bending Stress Ratio	=	0.622	1	Maximum Shear Stress Ratio	=	0.656	: 1
Section used for this span		5.25x11.875		Section used for this span		5.25x11.875	
fb: Actual		1,804.01 psi		fv: Actual		190.27 psi	
Fb: Allowable		2,900.00 psi		Fv: Allowable		290.00 psi	
Load Combination		+D+L+H		Load Combination		+D+L+H	
Location of maximum on span		4.500 ft		Location of maximum on span		8.015 ft	
Span # where maximum occurs		Span # 1		Span # where maximum occurs		Span # 1	
Maximum Deflection							
Max Downward Transient Deflection		0.115 in	Ratio = 940 >= 240				
Max Upward Transient Deflection		0.000 in	Ratio = 0 < 240				
Max Downward Total Deflection		0.158 in	Ratio = 682 >= 180				
Max Upward Total Deflection		0.000 in	Ratio = 0 < 180				

Overall Maximum Deflections

Load Combination	Span	Max. "-" Defl	Location in Span	Load Combination	Max. "+" Defl	Location in Span
+D+L+H	1	0.1582	4.599		0.0000	0.000

Vertical Reactions

Load Combination	Support # 1	Support # 2
Overall MAXimum	5.556	8.365
Overall MINimum	0.776	0.945
+D+H	1.488	2.355
+D+L+H	5.556	8.365

Use 3 1/2 x 16 PSL : S = 149.3, I = 1194.7

Wood Beam

File: examples.ec6

Software copyright ENERCALC, INC. 1983-2020. Build: 12.20.8.24

Lic. #: KW-06010224

D.S. ENGINEERING PC

DESCRIPTION: beam

**Vertical Reactions**

Support notation : Far left is #1

Values in KIPS

Load Combination	Support 1	Support 2
+D+Lr+H	1.488	2.355
+D+S+H	2.264	3.299
+D+0.750Lr+0.750L+H	4.539	6.862
+D+0.750L+0.750S+H	5.121	7.571
+D+0.60W+H	1.488	2.355
+D+0.70E+H	1.488	2.355
+D+0.750Lr+0.750L+0.450W+H	4.539	6.862
+D+0.750L+0.750S+0.450W+H	5.121	7.571
+D+0.750L+0.750S+0.5250E+H	5.121	7.571
+0.60D+0.60W+0.60H	0.893	1.413
+0.60D+0.70E+0.60H	0.893	1.413
D Only	1.488	2.355
L Only	4.068	6.010
S Only	0.776	0.945
H Only		

Wood Beam

Lic. #: KW-06010224

File: examples.ec6
 Software copyright ENERCALC, INC. 1983-2020, Build: 12.20.8.24
 D.S. ENGINEERING PC

DESCRIPTION: beam (stair)



CODE REFERENCES

Calculations per NDS 2018, IBC 2018, CBC 2019, ASCE 7-16

Load Combination Set : IBC 2018

Material Properties

Analysis Method : Allowable Stress Design	Fb +	2900 psi	E : Modulus of Elasticity	
Load Combination IBC 2018	Fb -	2900 psi	Ebend- xx	2200 ksi
	Fc - Prll	2900 psi	Eminbend - xx	1118.19 ksi
Wood Species : iLevel Truss Joist	Fc - Perp	750 psi		
Wood Grade : Parallam PSL 2.2E	Fv	290 psi		
	Ft	2025 psi	Density	45.07 pcf
Beam Bracing : Beam is Fully Braced against lateral-torsional buckling			Repetitive Member Stress Increase	

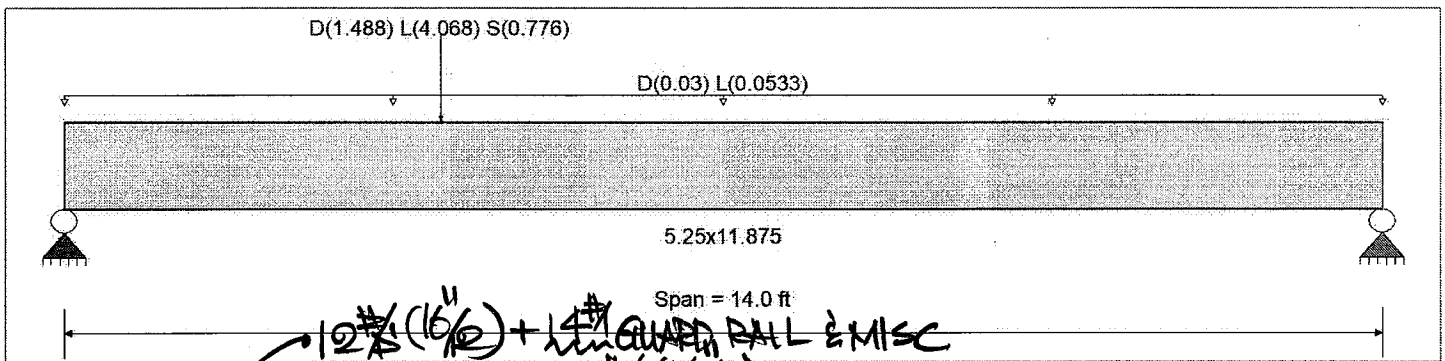

Applied Loads

Beam self weight calculated and added to loads

Uniform Load : D = 0.030, L = 0.05330, Tributary Width = 1.0 ft, (from 2nd floor)

Point Load : D = 1.488, L = 4.068, S = 0.7760 k @ 4.0 ft, (from 5.25x11.875 PSL)

Service loads entered. Load Factors will be applied for calculations.

DESIGN SUMMARY

Design OK

Maximum Bending Stress Ratio	=	0.577	Maximum Shear Stress Ratio	=	0.381 : 1
Section used for this span		5.25x11.875	Section used for this span		5.25x11.875
fb: Actual	=	1,739.26 psi	fv: Actual	=	110.40 psi
Fb: Allowable	=	3,016.00 psi	Fv: Allowable	=	290.00 psi
Load Combination	=	+D+L+H	Load Combination	=	+D+L+H
Location of maximum on span	=	4.036 ft	Location of maximum on span	=	0.000 ft
Span # where maximum occurs	=	Span # 1	Span # where maximum occurs	=	Span # 1
Maximum Deflection					
Max Downward Transient Deflection		0.223 in Ratio = 754 >= 240			
Max Upward Transient Deflection		0.000 in Ratio = 0 < 240			
Max Downward Total Deflection		0.320 in Ratio = 524 >= 180			
Max Upward Total Deflection		0.000 in Ratio = 0 < 180			

USE 3 1/2 x 16 PSL

Overall Maximum Deflections

Load Combination	Span	Max. "-" Defl	Location in Span	Load Combination	Max. "+" Defl	Location in Span
+D+L+H	1	0.3202	6.387		0.0000	0.000

Vertical Reactions

Support notation : Far left is #1

Values in KIPS

Load Combination	Support 1	Support 2
Overall MAXimum	4.688	2.307
Overall MINimum	0.554	0.222
+D+H	1.409	0.772
+D+L+H	4.688	2.307
+D+Lr+H	1.409	0.772
+D+S+H	1.964	0.993
+D+0.750Lr+0.750L+H	3.869	1.923
+D+0.750L+0.750S+H	4.284	2.090
+D+0.60W+H	1.409	0.772

Wood Beam

File: examples.ec6

Software copyright: ENERCALC, INC. 1983-2020, Build: 12.20.8.24

Lic. #: KW-06010224

D.S. ENGINEERING PC

DESCRIPTION: beam (stair)



Vertical Reactions

Support notation : Far left is #1

Values in KIPS

Load Combination	Support 1	Support 2
+D+0.70E+H	1.409	0.772
+D+0.750Lr+0.750L+0.450W+H	3.869	1.923
+D+0.750L+0.750S+0.450W+H	4.284	2.090
+D+0.750L+0.750S+0.5250E+H	4.284	2.090
+0.60D+0.60W+0.60H	0.846	0.463
+0.60D+0.70E+0.60H	0.846	0.463
D Only	1.409	0.772
L Only	3.279	1.535
S Only	0.554	0.222
H Only		

Wood Beam

Lic. #: KW-06010224

DESCRIPTION: header (F7)

CODE REFERENCES

Calculations per NDS 2018, IBC 2018, CBC 2019, ASCE 7-16

Load Combination Set : IBC 2018

Material Properties

Analysis Method : Allowable Stress Design	Fb +	875 psi	E : Modulus of Elasticity	
Load Combination IBC 2018	Fb -	875 psi	Ebend- xx	1300 ksi
	Fc - Prll	600 psi	Eminbend - xx	470 ksi
Wood Species : Douglas Fir-Larch	Fc - Perp	625 psi		
Wood Grade : No.2	Fv	170 psi		
Beam Bracing : Completely Unbraced	Ft	425 psi	Density	31.21 pcf

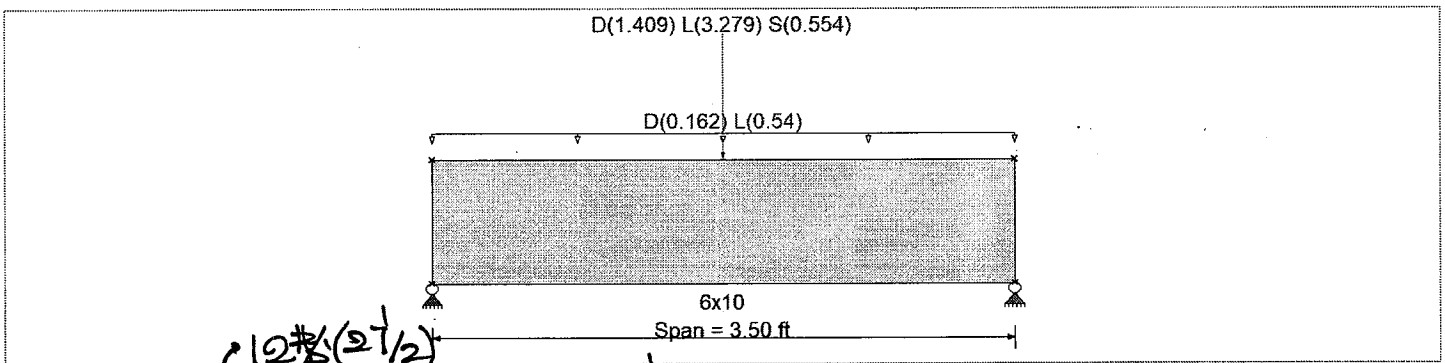

Applied Loads

Service loads entered. Load Factors will be applied for calculations.

Beam self weight calculated and added to loads

Uniform Load : D = 0.1620, L = 0.540, Tributary Width = 1.0 ft

Point Load : D = 1.409, L = 3.279, S = 0.554 k @ 1.750 ft, (from 3.5x16 PSL (F6))

DESIGN SUMMARY

Design OK

Maximum Bending Stress Ratio	=	0.863	1	Maximum Shear Stress Ratio	=	0.513	: 1
Section used for this span		6x10		Section used for this span		6x10	
fb: Actual	=	753.44 psi		fv: Actual	=	87.17 psi	
Fb: Allowable	=	873.08 psi		Fv: Allowable	=	170.00 psi	
Load Combination		+D+L		Load Combination		+D+L	
Location of maximum on span	=	1.750ft		Location of maximum on span	=	2.721 ft	
Span # where maximum occurs	=	Span # 1		Span # where maximum occurs	=	Span # 1	
Maximum Deflection							
Max Downward Transient Deflection		0.014 in	Ratio = 3099			>=360	
Max Upward Transient Deflection		0.000 in	Ratio = 0			<360	
Max Downward Total Deflection		0.019 in	Ratio = 2212			>=180	
Max Upward Total Deflection		0.000 in	Ratio = 0			<180	

Overall Maximum Deflections

Load Combination	Span	Max. " Defl	Location in Span	Load Combination	Max. "+" Defl	Location in Span
+D+L	1	0.0190	1.763		0.0000	0.000

Vertical Reactions

Support notation : Far left is #1

Values in KIPS

Load Combination	Support 1	Support 2
Overall MAXimum	3.592	3.592
Overall MINimum	0.277	0.277
D Only	1.008	1.008
+D+L	3.592	3.592
+D+S	1.285	1.285
+D+0.750L	2.946	2.946
+D+0.750L+0.750S	3.154	3.154
+0.60D	0.605	0.605
L Only	2.585	2.585

Wood Beam

File: examples.ec6

Software copyright ENERCALC, INC. 1983-2020, Build:12.20.8.24

Lic. # : KW-06010224

D.S. ENGINEERING PC

DESCRIPTION: header (F7)

Vertical Reactions

Support notation : Far left is #1

Values in KIPS

Load Combination	Support 1	Support 2
S Only	0.277	0.277

Wood Beam

File: examples.ec6
 Software copyright ENERCALC, INC. 1983-2020, Build:12.20.8.24
 D.S. ENGINEERING PC

Lic. #: KW-06010224

DESCRIPTION: header (F8)

CODE REFERENCES

Calculations per NDS 2018, IBC 2018, CBC 2019, ASCE 7-16
 Load Combination Set : IBC 2018

Material Properties

Analysis Method : Allowable Stress Design	Fb +	875 psi	E : Modulus of Elasticity	
Load Combination IBC 2018	Fb -	875 psi	Ebend- xx	1300 ksi
Wood Species : Douglas Fir-Larch	Fc - Prll	600 psi	Eminbend - xx	470 ksi
Wood Grade : No.2	Fc - Perp	625 psi		
Beam Bracing : Completely Unbraced	Fv	170 psi	Density	31.21 pcf
	Ft	425 psi		

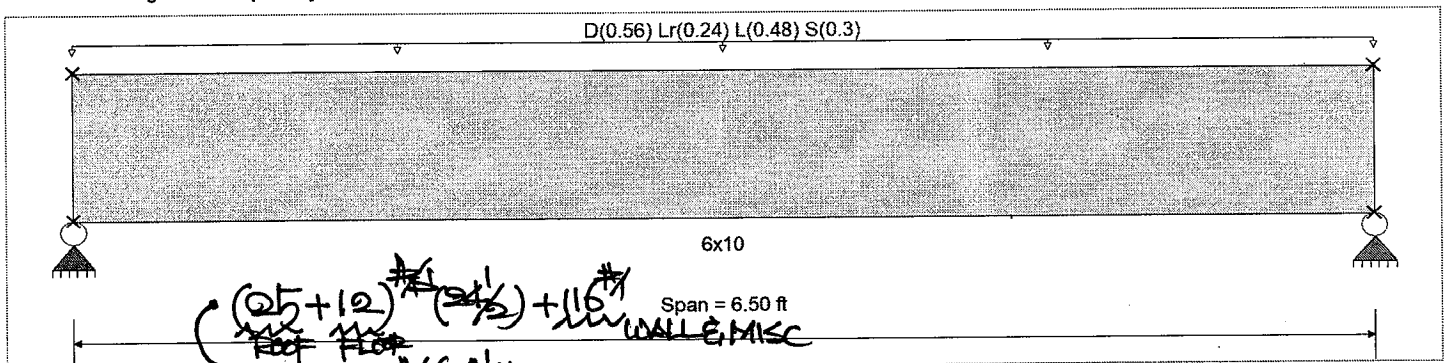

Applied Loads

Service loads entered. Load Factors will be applied for calculations.

Beam self weight calculated and added to loads
 Uniform Load : D = 0.560, Lr = 0.240, L = 0.480, S = 0.30, Tributary Width = 1.0 ft

DESIGN SUMMARY

Maximum Bending Stress Ratio	=	0.924	1	Maximum Shear Stress Ratio	=	0.438	: 1
Section used for this span		6x10		Section used for this span		6x10	
fb: Actual	=	805.37 psi		fv: Actual	=	74.46 psi	
Fb: Allowable	=	871.44 psi		Fv: Allowable	=	170.00 psi	
Load Combination		+D+L		Load Combination		+D+L	
Location of maximum on span	=	3.250 ft		Location of maximum on span	=	5.717 ft	
Span # where maximum occurs	=	Span # 1		Span # where maximum occurs	=	Span # 1	
Maximum Deflection							
Max Downward Transient Deflection		0.038 in	Ratio = 2054			>=360	
Max Upward Transient Deflection		0.000 in	Ratio = 0			<360	
Max Downward Total Deflection		0.091 in	Ratio = 852			>=240	
Max Upward Total Deflection		0.000 in	Ratio = 0			<240	

Design OK

Overall Maximum Deflections

Load Combination	Span	Max. "+" Defl	Location in Span	Load Combination	Max. "+" Defl	Location in Span
+D+0.750L+0.750S	1	0.0914	3.274		0.0000	0.000

Vertical Reactions

Support notation : Far left is #1

Values in KIPS

Load Combination	Support 1	Support 2
Overall MAXimum	3.758	3.758
Overall MINimum	0.975	0.975
D Only	1.857	1.857
+D+L	3.417	3.417
+D+Lr	2.637	2.637
+D+S	2.832	2.832
+D+0.750Lr+0.750L	3.612	3.612
+D+0.750L+0.750S	3.758	3.758
+0.60D	1.114	1.114
Lr Only	0.780	0.780

Wood Beam

File: examples.ecb

Software copyright: ENERCALC, INC. 1983-2020, Build: 12.20.8.24

Lic. # : KW-06010224

D.S. ENGINEERING PC

DESCRIPTION: header (F8)

Vertical Reactions

Support notation : Far left is #1

Values in KIPS

Load Combination	Support 1	Support 2
L Only	1.560	1.560
S Only	0.975	0.975

Wood Beam

Lic. #: KW-06010224

File: examples.ec6
Software copyright ENERCALC, INC. 1983-2020, Build:12.20.8.24

D.S. ENGINEERING PC

DESCRIPTION: header (S) (F9)

CODE REFERENCES

Calculations per NDS 2018, IBC 2018, CBC 2019, ASCE 7-16

Load Combination Set : IBC 2018

Material Properties

Analysis Method : Allowable Stress Design
Load Combination IBC 2018

Fb +	900 psi	E : Modulus of Elasticity	
Fb -	900 psi	Ebend-xx	1600 ksi
Fc - Prll	1350 psi	Eminbend - xx	580 ksi
Fc - Perp	625 psi		
Fv	180 psi		
Ft	575 psi	Density	31.21 pcf

Wood Species : Douglas Fir-Larch
Wood Grade : No.2

Beam Bracing : Completely Unbraced

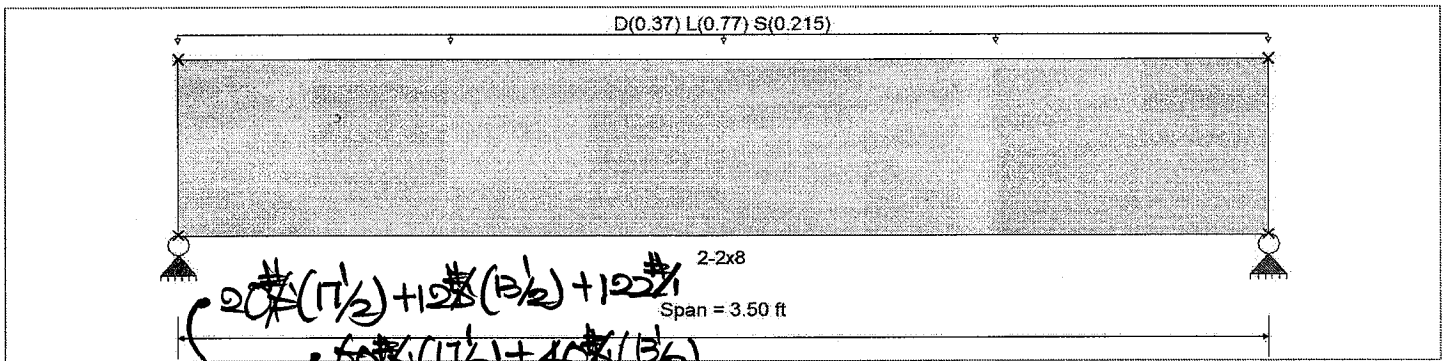

Applied Loads

Service loads entered. Load Factors will be applied for calculations.

Beam self weight calculated and added to loads

Uniform Load : D = 0.370, L = 0.770, S = 0.2150, Tributary Width = 1.0 ft, (from floor + roof deck)

DESIGN SUMMARY

Design OK

Maximum Bending Stress Ratio	=	0.746	1	Maximum Shear Stress Ratio	=	0.504	: 1
Section used for this span		2-2x8		Section used for this span		2-2x8	
fb: Actual	=	800.35	psi	fv: Actual	=	90.76	psi
Fb: Allowable	=	1,073.53	psi	Fv: Allowable	=	180.00	psi
Load Combination		+D+L+H		Load Combination		+D+L+H	
Location of maximum on span	=	1.750	ft	Location of maximum on span	=	2.900	ft
Span # where maximum occurs	=	Span # 1		Span # where maximum occurs	=	Span # 1	
Maximum Deflection							
Max Downward Transient Deflection		0.017	in	Ratio =		2448	>=240
Max Upward Transient Deflection		0.000	in	Ratio =		0	<240
Max Downward Total Deflection		0.026	in	Ratio =		1646	>=180
Max Upward Total Deflection		0.000	in	Ratio =		0	<180

Overall Maximum Deflections

Load Combination	Span	Max. "-" Defl	Location in Span	Load Combination	Max. "+" Defl	Location in Span
+D+L+H	1	0.0255	1.763		0.0000	0.000

Vertical Reactions

Support notation : Far left is #1

Values in KIPS

Load Combination	Support 1	Support 2
Overall MAXimum	2.003	2.003
Overall MINimum	0.376	0.376
+D+H	0.656	0.656
+D+L+H	2.003	2.003
+D+Lr+H	0.656	0.656
+D+S+H	1.032	1.032
+D+0.750Lr+0.750L+H	1.666	1.666
+D+0.750L+0.750S+H	1.949	1.949
+D+0.60W+H	0.656	0.656
+D+0.70E+H	0.656	0.656

Wood Beam

File: examples.ec6

Software copyright ENERCALC, INC. 1983-2020. Build: 12.20.8.24

Lic. #: KW-06010224

D.S. ENGINEERING PC

DESCRIPTION: header (S) (F9)

Vertical Reactions

Support notation : Far left is #1

Values in KIPS

Load Combination	Support 1	Support 2
+D+0.750Lr+0.750L+0.450W+H	1.666	1.666
+D+0.750L+0.750S+0.450W+H	1.949	1.949
+D+0.750L+0.750S+0.5250E+H	1.949	1.949
+0.60D+0.60W+0.60H	0.393	0.393
+0.60D+0.70E+0.60H	0.393	0.393
D Only	0.656	0.656
L Only	1.348	1.348
S Only	0.376	0.376
H Only		

Wood Beam

Lic. #: KW-06010224

File: examples.ec6
Software copyright: ENERCALC, INC. 1983-2020, Build: 12.20.8.24

D.S. ENGINEERING PC

DESCRIPTION: header (F10)

CODE REFERENCES

Calculations per NDS 2018, IBC 2018, CBC 2019, ASCE 7-16

Load Combination Set : IBC 2018

Material Properties

Analysis Method : Allowable Stress Design
Load Combination IBC 2018

Wood Species : DF/DF
Wood Grade : 24F-V4

Beam Bracing : Completely Unbraced

Fb +	2,400.0 psi	E : Modulus of Elasticity	
Fb -	1,850.0 psi	Ebend-xx	1,800.0 ksi
Fc - Prll	1,650.0 psi	Eminbend -xx	950.0 ksi
Fc - Perp	650.0 psi	Ebend-yy	1,600.0 ksi
Fv	265.0 psi	Eminbend -yy	850.0 ksi
Ft	1,100.0 psi	Density	31.210 pcf

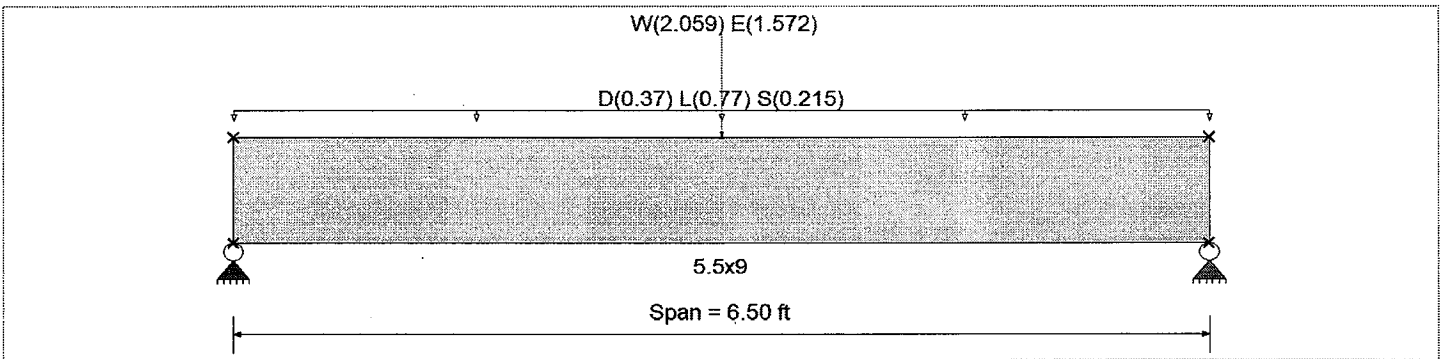

Applied Loads

Service loads entered. Load Factors will be applied for calculations.

Beam self weight calculated and added to loads

Uniform Load : D = 0.370, L = 0.770, S = 0.2150, Tributary Width = 1.0 ft, (see (F9))

Point Load : W = 2.059, E = 1.572 k @ 3.250 ft, (from shearwall Calc)

DESIGN SUMMARY

Design OK

Maximum Bending Stress Ratio	=	0.411 : 1	Maximum Shear Stress Ratio	=	0.331 : 1
Section used for this span		5.5x9	Section used for this span		5.5x9
fb: Actual	=	982.19 psi	fv: Actual	=	87.69 psi
Fb: Allowable	=	2,387.32 psi	Fv: Allowable	=	265.00 psi
Load Combination		+D+L	Load Combination		+D+L
Location of maximum on span	=	3.250 ft	Location of maximum on span	=	5.765 ft
Span # where maximum occurs	=	Span # 1	Span # where maximum occurs	=	Span # 1
Maximum Deflection					
Max Downward Transient Deflection		0.052 in	Ratio =		1508 >= 360
Max Upward Transient Deflection		0.000 in	Ratio =		0 < 360
Max Downward Total Deflection		0.091 in	Ratio =		861 >= 240
Max Upward Total Deflection		0.000 in	Ratio =		0 < 240

Overall Maximum Deflections

Load Combination	Span	Max. "-" Defl	Location in Span	Load Combination	Max. "+" Defl	Location in Span
+D+0.750L+0.750S+0.450W	1	0.0905	3.274		0.0000	0.000

Vertical Reactions

Support notation : Far left is #1

Values in KIPS

Load Combination	Support 1	Support 2
Overall MAXimum	4.102	4.102
Overall MINimum	0.786	0.786
D Only	1.237	1.237
+D+L	3.740	3.740
+D+S	1.936	1.936
+D+0.750L	3.114	3.114
+D+0.750L+0.750S	3.638	3.638
+D+0.60W	1.855	1.855
+D+0.70E	1.788	1.788

Wood Beam

File: examples.ecb

Software copyright: ENERCALC, INC. 1983-2020, Build: 12.20.8.24

Lic. #: KW-06010224

D.S. ENGINEERING PC

DESCRIPTION: header (F10)

Vertical Reactions

Support notation : Far left is #1

Values in KIPS

Load Combination	Support 1	Support 2
+D+0.750L+0.450W	3.578	3.578
+D+0.750L+0.750S+0.450W	4.102	4.102
+D+0.750L+0.750S+0.5250E	4.051	4.051
+0.60D+0.60W	1.360	1.360
+0.60D+0.70E	1.293	1.293
L Only	2.503	2.503
S Only	0.699	0.699
W Only	1.030	1.030
E Only	0.786	0.786

Wood Beam

Lic. #: KW-06010224

File: examples.ec6
 Software copyright ENERCALC, INC. 1983-2020, Build: 12.20.8.24
 D.S. ENGINEERING PC

DESCRIPTION: header (F11)

CODE REFERENCES

Calculations per NDS 2018, IBC 2018, CBC 2019, ASCE 7-16

Load Combination Set : IBC 2018

Material Properties

Analysis Method : Allowable Stress Design
 Load Combination IBC 2018

Wood Species : DF/DF
 Wood Grade : 24F-V4

Beam Bracing : Completely Unbraced

Fb +	2,400.0 psi	E : Modulus of Elasticity	
Fb -	1,850.0 psi	Ebend-xx	1,800.0 ksi
Fc - Prll	1,650.0 psi	Eminbend - xx	950.0 ksi
Fc - Perp	650.0 psi	Ebend-yy	1,600.0 ksi
Fv	265.0 psi	Eminbend - yy	850.0 ksi
Ft	1,100.0 psi	Density	31.210 pcf

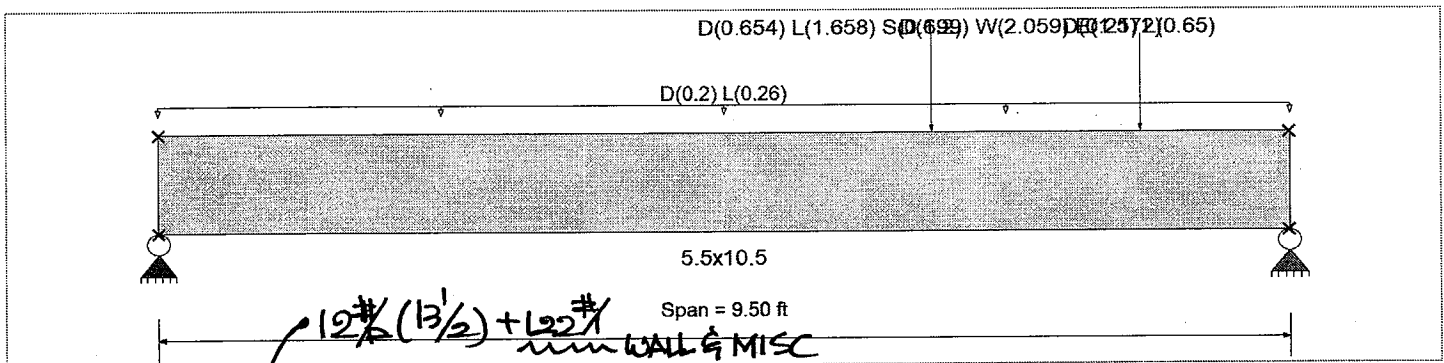

Applied Loads

Service loads entered. Load Factors will be applied for calculations.

Beam self weight calculated and added to loads

Uniform Load : D = 0.20, L = 0.260, Tributary Width = 1.0 ft, (see (F11))

Point Load : D = 0.6540, L = 1.658, S = 0.6990, W = 2.059, E = 1.572 k @ 6.50 ft, (from shearwall Calc & header (R2))

Point Load : D = 1.20 k @ 6.50 ft, (from wall)

Point Load : D = 0.210, L = 0.650 k @ 8.250 ft, (from stair)

DESIGN SUMMARY

Maximum Bending Stress Ratio	=	0.626	1	Maximum Shear Stress Ratio	=	0.489	: 1
Section used for this span	=	5.5x10.5		Section used for this span	=	5.5x10.5	
fb: Actual	=	1,489.56	psi	fv: Actual	=	129.47	psi
Fb: Allowable	=	2,377.80	psi	Fv: Allowable	=	265.00	psi
Load Combination	=	+D+L		Load Combination	=	+D+L	
Location of maximum on span	=	6.484	ft	Location of maximum on span	=	8.633	ft
Span # where maximum occurs	=	Span # 1		Span # where maximum occurs	=	Span # 1	
Maximum Deflection							
Max Downward Transient Deflection		0.103	in	Ratio =		1107	>=360
Max Upward Transient Deflection		0.000	in	Ratio =		0	<360
Max Downward Total Deflection		0.210	in	Ratio =		543	>=240
Max Upward Total Deflection		0.000	in	Ratio =		0	<240

Design OK

Overall Maximum Deflections

Load Combination	Span	Max. "-" Defl	Location in Span	Load Combination	Max. "+" Defl	Location in Span
+D+0.750L+0.750S+0.450W	1	0.2097	5.062		0.0000	0.000

Vertical Reactions

Support notation : Far left is #1

Values in KIPS

Load Combination	Support 1	Support 2
Overall MAXimum	3.467	5.653
Overall MINimum	0.496	1.076
D Only	1.623	2.460
+D+L	3.467	5.394
+D+S	1.843	2.939
+D+0.750L	3.006	4.661
+D+0.750L+0.750S	3.171	5.019

Wood BeamFile: examples.ecb
Software copyright ENERCALC, INC. 1983-2020; Build: 12.20.8.24
D.S. ENGINEERING PC

Lic. #: KW-06010224

DESCRIPTION: header (F11)

Vertical Reactions	Support notation : Far left is #1		Values in KIPS
	Support 1	Support 2	
Load Combination			
+D+0.60W	2.013	3.306	
+D+0.70E	1.970	3.213	
+D+0.750L+0.450W	3.298	5.295	
+D+0.750L+0.750S+0.450W	3.464	5.653	
+D+0.750L+0.750S+0.5250E	3.432	5.584	
+0.60D+0.60W	1.364	2.321	
+0.60D+0.70E	1.321	2.229	
L Only	1.844	2.934	
S Only	0.221	0.478	
W Only	0.650	1.409	
E Only	0.496	1.076	

Wood Beam

Lic. #: KW-06010224

File: examples.ec6
Software copyright ENERCALC, INC. 1983-2020, Build: 12.20.8.24

D.S. ENGINEERING PC

DESCRIPTION: header (W&E)

F12

CODE REFERENCES

Calculations per NDS 2018, IBC 2018, CBC 2019, ASCE 7-16

Load Combination Set : IBC 2018

Material Properties

Analysis Method : Allowable Stress Design
Load Combination IBC 2018

Fb +	900 psi	E : Modulus of Elasticity	
Fb -	900 psi	Ebend- xx	1600 ksi
Fc - Prll	1350 psi	Eminbend - xx	580 ksi
Fc - Perp	625 psi		
Fv	180 psi		
Ft	575 psi	Density	31.21 pcf

Wood Species : Douglas Fir-Larch
Wood Grade : No.2

Beam Bracing : Completely Unbraced

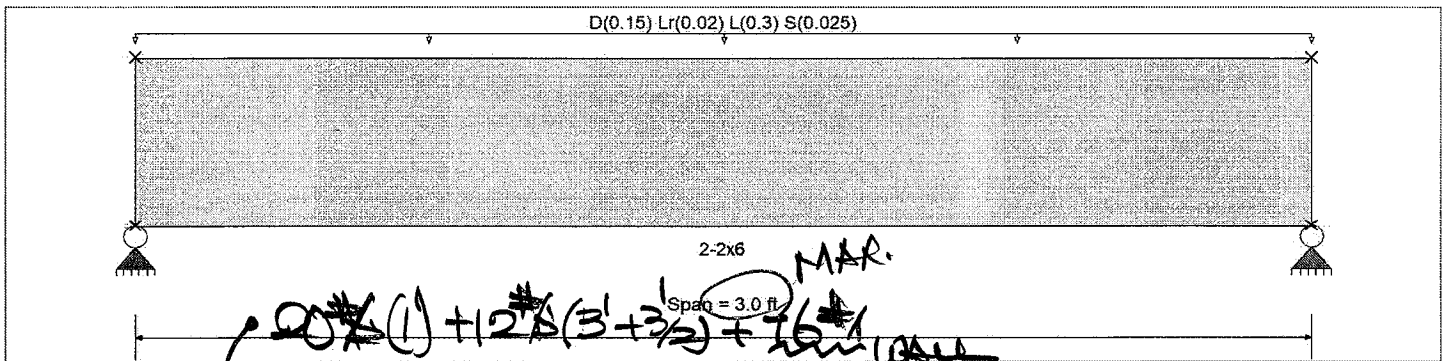

Applied Loads

Beam self weight calculated and added to loads

Uniform Load : D = 0.150, Lr = 0.020, L = 0.30, S = 0.0250, Tributary Width = 1.0 ft, (from floor + deck + roof)

Service loads entered. Load Factors will be applied for calculations.

DESIGN SUMMARY

Maximum Bending Stress Ratio	=	0.347	1	Maximum Shear Stress Ratio	=	0.241	1
Section used for this span		2-2x6		Section used for this span		2-2x6	
fb: Actual	=	404.84 psi		fv: Actual	=	43.34 psi	
Fb: Allowable	=	1,165.22 psi		Fv: Allowable	=	180.00 psi	
Load Combination		+D+L+H		Load Combination		+D+L+H	
Location of maximum on span	=	1.500 ft		Location of maximum on span	=	0.000 ft	
Span # where maximum occurs	=	Span # 1		Span # where maximum occurs	=	Span # 1	
Maximum Deflection							
Max Downward Transient Deflection		0.008 in	Ratio =	4356	>=	240	
Max Upward Transient Deflection		0.000 in	Ratio =	0	<	240	
Max Downward Total Deflection		0.012 in	Ratio =	2881	>=	180	
Max Upward Total Deflection		0.000 in	Ratio =	0	<	180	

Overall Maximum Deflections

Load Combination	Span	Max. "-" Defl	Location in Span	Load Combination	Max. "+" Defl	Location in Span
+D+L+H	1	0.0125	1.511		0.0000	0.000

Vertical Reactions

Support notation : Far left is #1

Values in KIPS

Load Combination	Support 1	Support 2
Overall MAXimum	0.680	0.680
Overall MINimum	0.038	0.038
+D+H	0.230	0.230
+D+L+H	0.680	0.680
+D+Lr+H	0.260	0.260
+D+S+H	0.268	0.268
+D+0.750Lr+0.750L+H	0.590	0.590
+D+0.750L+0.750S+H	0.596	0.596
+D+0.60W+H	0.230	0.230
+D+0.70E+H	0.230	0.230

Wood Beam

File: examples.ec6

Software copyright ENERCALC, INC. 1983-2020, Build:12.20.8.24

Lic. #: KW-06010224

D.S. ENGINEERING PC

DESCRIPTION: header (W&E)

F12**Vertical Reactions**

Support notation : Far left is #1

Values in KIPS

Load Combination	Support 1	Support 2
+D+0.750Lr+0.750L+0.450W+H	0.590	0.590
+D+0.750L+0.750S+0.450W+H	0.596	0.596
+D+0.750L+0.750S+0.5250E+H	0.596	0.596
+0.60D+0.60W+0.60H	0.138	0.138
+0.60D+0.70E+0.60H	0.138	0.138
D Only	0.230	0.230
Lr Only	0.030	0.030
L Only	0.450	0.450
S Only	0.038	0.038
H Only		

Wood Beam

Lic. #: KW-06010224

File: examples.ec6
Software copyright ENERCALC, INC. 1983-2020, Build:12.20.8.24

D.S. ENGINEERING PC

DESCRIPTION: header (W)

F13

CODE REFERENCES

Calculations per NDS 2018, IBC 2018, CBC 2019, ASCE 7-16

Load Combination Set : IBC 2018

Material Properties

Analysis Method : Allowable Stress Design
Load Combination IBC 2018

Wood Species : Douglas Fir-Larch
Wood Grade : No.2

Beam Bracing : Completely Unbraced

Fb +	900 psi	E : Modulus of Elasticity	
Fb -	900 psi	Ebend- xx	1600ksi
Fc - Prll	1350 psi	Eminbend - xx	580 ksi
Fc - Perp	625 psi		
Fv	180 psi		
Ft	575 psi	Density	31.21 pcf

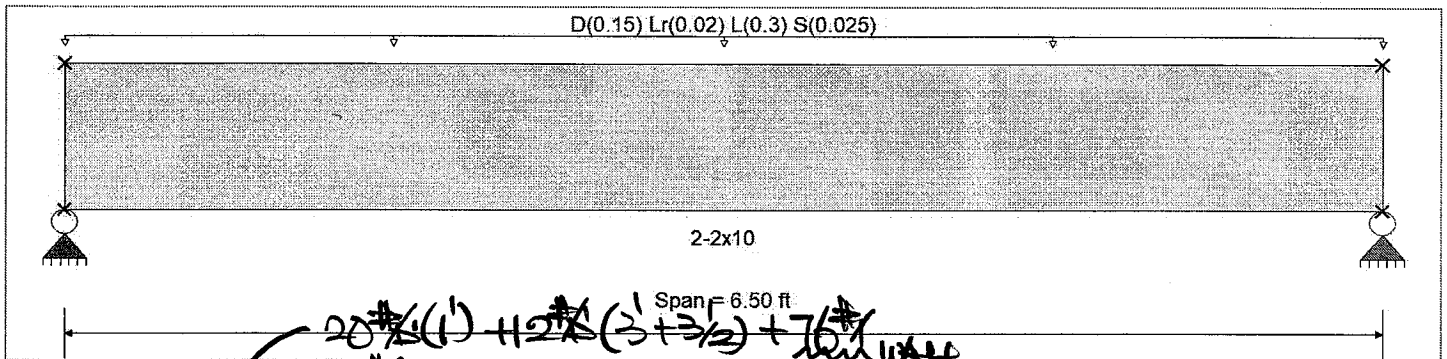

Applied Loads

Beam self weight calculated and added to loads

Uniform Load : D = 0.150, Lr = 0.020, L = 0.30, S = 0.0250, Tributary Width = 1.0 ft, (from floor + deck + roof)

DESIGN SUMMARY

Maximum Bending Stress Ratio	=	0.692	1	Maximum Shear Stress Ratio	=	0.341	: 1
Section used for this span		2-2x10		Section used for this span		2-2x10	
fb: Actual	=	675.53 psi		fv: Actual	=	61.40 psi	
Fb: Allowable	=	975.98 psi		Fv: Allowable	=	180.00 psi	
Load Combination		+D+L+H		Load Combination		+D+L+H	
Location of maximum on span	=	3.250 ft		Location of maximum on span	=	5.741 ft	
Span # where maximum occurs	=	Span # 1		Span # where maximum occurs	=	Span # 1	
Maximum Deflection							
Max Downward Transient Deflection		0.038 in	Ratio = 2037	>=240			
Max Upward Transient Deflection		0.000 in	Ratio = 0	<240			
Max Downward Total Deflection		0.058 in	Ratio = 1340	>=180			
Max Upward Total Deflection		0.000 in	Ratio = 0	<180			

Overall Maximum Deflections

Load Combination	Span	Max. "-" Defl	Location in Span	Load Combination	Max. "+" Defl	Location in Span
+D+L+H	1	0.0582	3.274		0.0000	0.000

Vertical Reactions

Support notation : Far left is #1

Values in KIPS

Load Combination	Support 1	Support 2
Overall MAXimum	1.482	1.482
Overall MINimum	0.081	0.081
+D+H	0.507	0.507
+D+L+H	1.482	1.482
+D+Lr+H	0.572	0.572
+D+S+H	0.588	0.588
+D+0.750Lr+0.750L+H	1.287	1.287
+D+0.750L+0.750S+H	1.299	1.299
+D+0.60W+H	0.507	0.507
+D+0.70E+H	0.507	0.507

Wood Beam

File: examples.ec6

Software copyright ENERCALC, INC. 1983-2020, Build: 12.20.8.24

Lic. #: KW-06010224

D.S. ENGINEERING PC

DESCRIPTION: header (W)

F13

Vertical Reactions

Support notation : Far left is #1

Values in KIPS

Load Combination	Support 1	Support 2
+D+0.750Lr+0.750L+0.450W+H	1.287	1.287
+D+0.750L+0.750S+0.450W+H	1.299	1.299
+D+0.750L+0.750S+0.5250E+H	1.299	1.299
+0.60D+0.60W+0.60H	0.304	0.304
+0.60D+0.70E+0.60H	0.304	0.304
D Only	0.507	0.507
Lr Only	0.065	0.065
L Only	0.975	0.975
S Only	0.081	0.081
H Only		

Wood Beam

File: examples.ecb
 Software copyright: ENERCALC, INC. 1983-2020; Build: 12.20.8.24
 D.S. ENGINEERING PC

Lic. #: KW-06010224

DESCRIPTION: header (F14)

CODE REFERENCES

Calculations per NDS 2018, IBC 2018, CBC 2019, ASCE 7-16
 Load Combination Set : IBC 2018

Material Properties

Analysis Method : Allowable Stress Design	Fb +	2400 psi	E : Modulus of Elasticity	
Load Combination IBC 2018	Fb -	1850 psi	Ebend- xx	1800 ksi
	Fc - Prll	1650 psi	Eminbend - xx	950 ksi
Wood Species : DF/DF	Fc - Perp	650 psi	Ebend- yy	1600 ksi
Wood Grade : 24F-V4	Fv	265 psi	Eminbend - yy	850 ksi
	Ft	1100 psi	Density	31.21 pcf
Beam Bracing : Completely Unbraced				

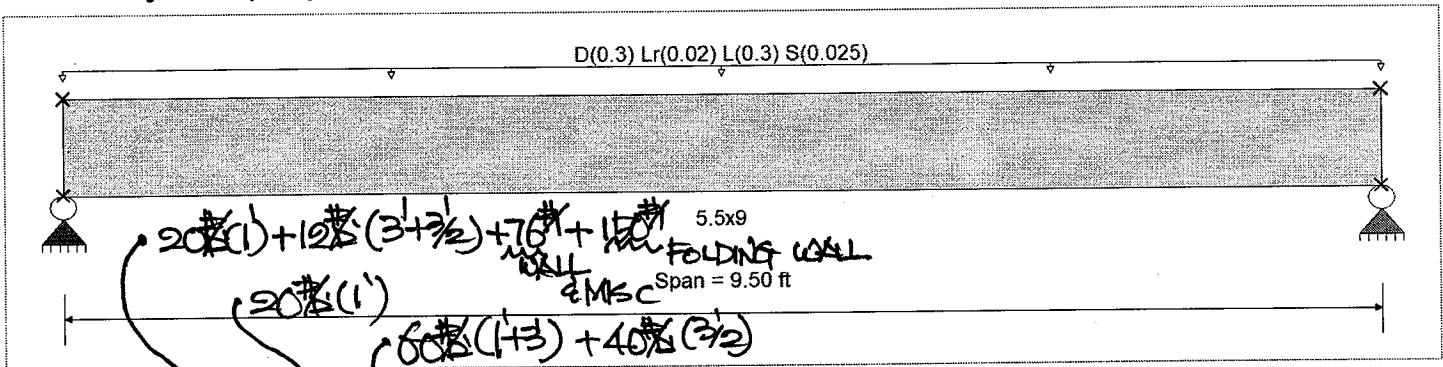

Applied Loads

Service loads entered. Load Factors will be applied for calculations.

Beam self weight calculated and added to loads

Uniform Load : D = 0.30, Lr = 0.020, L = 0.30, S = 0.0250, Tributary Width = 1.0 ft, (from 2nd floor + deck + roof)

DESIGN SUMMARY

Design OK

Maximum Bending Stress Ratio	=	0.467 : 1	Maximum Shear Stress Ratio	=	0.281 : 1
Section used for this span		5.5x9	Section used for this span		5.5x9
fb: Actual	=	1,113.50 psi	fv: Actual	=	74.43 psi
Fb: Allowable	=	2,381.84 psi	Fv: Allowable	=	265.00 psi
Load Combination		+D+L	Load Combination		+D+L
Location of maximum on span	=	4.750 ft	Location of maximum on span	=	8.772 ft
Span # where maximum occurs	=	Span # 1	Span # where maximum occurs	=	Span # 1
Maximum Deflection					
Max Downward Transient Deflection		0.092 in Ratio =	1239 >= 360		
Max Upward Transient Deflection		0.000 in Ratio =	0 < 360		
Max Downward Total Deflection		0.187 in Ratio =	609 >= 240		
Max Upward Total Deflection		0.000 in Ratio =	0 < 240		

Overall Maximum Deflections

Load Combination	Span	Max. "+" Defl	Location in Span	Load Combination	Max. "+" Defl	Location in Span
+D+L	1	0.1872	4.785		0.0000	0.000

Vertical Reactions

Support notation : Far left is #1

Values in KIPS

Load Combination	Support 1	Support 2
Overall MAXimum	2.901	2.901
Overall MINimum	0.119	0.119
D Only	1.476	1.476
+D+L	2.901	2.901
+D+Lr	1.571	1.571
+D+S	1.595	1.595
+D+0.750Lr+0.750L	2.616	2.616
+D+0.750L+0.750S	2.634	2.634
+0.60D	0.886	0.886
Lr Only	0.095	0.095

Wood Beam

File: examples.ec6

Software copyright: ENERCALC, INC. 1983-2020, Build: 12.20.8.24

Lic. # : KW-06010224

D.S. ENGINEERING PC

DESCRIPTION: header (F14)

Vertical Reactions

Support notation : Far left is #1

Values in KIPS

Load Combination	Support 1	Support 2
L Only	1.425	1.425
S Only	0.119	0.119

Wood Beam

Lic. #: KW-06010224

File: examples.ec6
Software copyright ENERCALC, INC. 1983-2020, Build:12.20.8.24

D.S. ENGINEERING PC

DESCRIPTION: beam (F15)

CODE REFERENCES

Calculations per NDS 2018, IBC 2018, CBC 2019, ASCE 7-16

Load Combination Set : IBC 2018

Material Properties

Analysis Method : Allowable Stress Design	Fb +	2900 psi	E : Modulus of Elasticity	
Load Combination IBC 2018	Fb -	2900 psi	Ebend- xx	2200ksi
	Fc - Prll	2900 psi	Eminbend - xx	1118.19ksi
Wood Species : iLevel Truss Joist	Fc - Perp	750 psi		
Wood Grade : Parallam PSL 2.2E	Fv	290 psi		
	Ft	2025 psi	Density	45.07pcf
Beam Bracing : Beam is Fully Braced against lateral-torsional buckling				

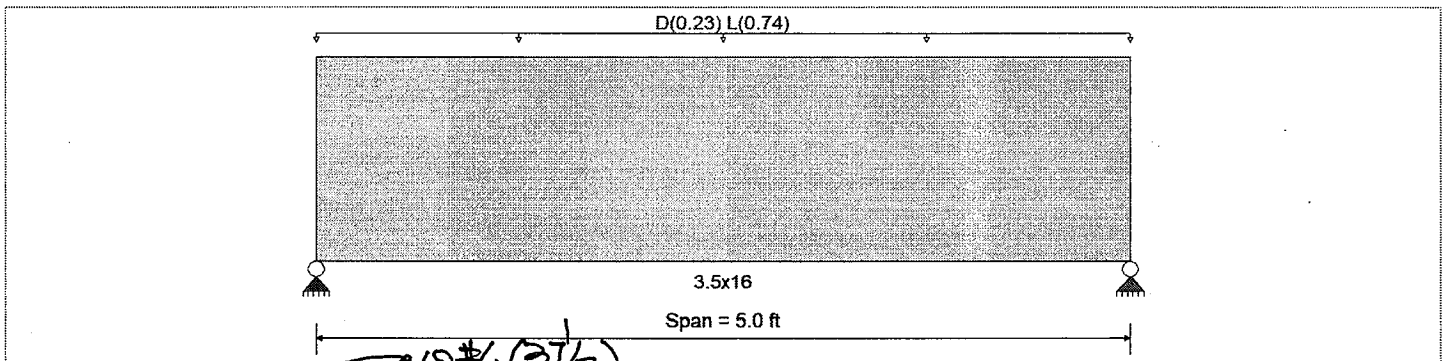

Applied Loads

Service loads entered. Load Factors will be applied for calculations.

Beam self weight calculated and added to loads
Uniform Load : D = 0.230, L = 0.740, Tributary Width = 1.0 ft

DESIGN SUMMARY

Design OK

Maximum Bending Stress Ratio =	0.086	1	Maximum Shear Stress Ratio =	0.107	: 1
Section used for this span	3.5x16		Section used for this span	3.5x16	
fb: Actual =	247.98	psi	fv: Actual =	30.89	psi
Fb: Allowable =	2,900.00	psi	Fv: Allowable =	290.00	psi
Load Combination =	+D+L		Load Combination =	+D+L	
Location of maximum on span =	2.500	ft	Location of maximum on span =	0.000	ft
Span # where maximum occurs =	Span # 1		Span # where maximum occurs =	Span # 1	
Maximum Deflection					
Max Downward Transient Deflection	0.004	in	Ratio =	15066	>=360
Max Upward Transient Deflection	0.000	in	Ratio =	0	<360
Max Downward Total Deflection	0.005	in	Ratio =	11289	>=240
Max Upward Total Deflection	0.000	in	Ratio =	0	<240

Overall Maximum Deflections

Load Combination	Span	Max. "-" Defl	Location in Span	Load Combination	Max. "+" Defl	Location in Span
+D+L	1	0.0053	2.518		0.0000	0.000

Vertical Reactions

Support notation : Far left is #1

Values in KIPS

Load Combination	Support 1	Support 2
Overall MAXimum	2.469	2.469
Overall MINimum	1.850	1.850
D Only	0.619	0.619
+D+L	2.469	2.469
+D+0.750L	2.006	2.006
+0.60D	0.371	0.371
L Only	1.850	1.850

Handwritten notes:
 ← #U416 (2975#)
 OR
 #U3.56/16
 (3455#)

Level, Floor: Joist
1 piece(s) 16" TJI® 360 @ 16" OC

Overall Length: 23' 6"

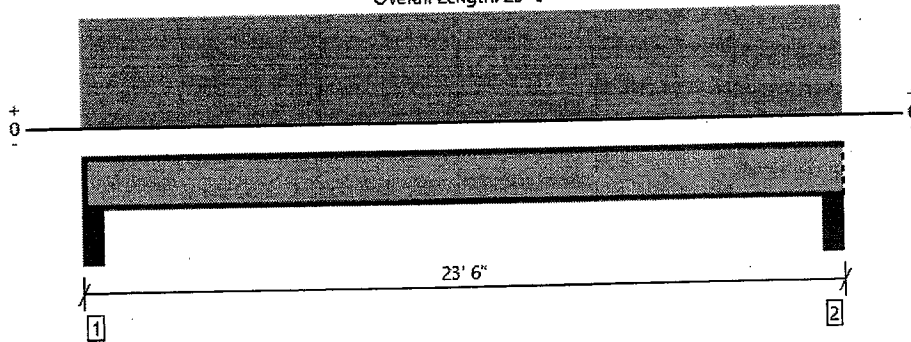

All locations are measured from the outside face of left support (or left cantilever end). All dimensions are horizontal.

Design Results	Actual @ Location	Allowed	Result	LDf	Load: Combination (Pattern)
Member Reaction (lbs)	815 @ 23' 1 1/2"	1505 (3.50")	Passed (54%)	1.00	1.0 D + 1.0 L (All Spans)
Shear (lbs)	783 @ 5 1/2"	2190	Passed (36%)	1.00	1.0 D + 1.0 L (All Spans)
Moment (Ft-lbs)	4486 @ 11' 9"	8405	Passed (53%)	1.00	1.0 D + 1.0 L (All Spans)
Live Load Defl. (in)	0.378 @ 11' 9"	0.569	Passed (L/723)	--	1.0 D + 1.0 L (All Spans)
Total Load Defl. (in)	0.491 @ 11' 9"	1.138	Passed (L/556)	--	1.0 D + 1.0 L (All Spans)
TJ-Pro™ Rating	40	40	Passed	--	--

System : Floor
 Member Type : Joist
 Building Use : Residential
 Building Code : IBC 2018
 Design Methodology : ASD

- Deflection criteria: LL (L/480) and TL (L/240).
- Allowed moment does not reflect the adjustment for the beam stability factor.
- A structural analysis of the deck has not been performed.
- Deflection analysis is based on composite action with a single layer of 23/32" Weyerhaeuser Edge™ Panel (24" Span Rating) that is glued and nailed down.
- Additional considerations for the TJ-Pro™ Rating include: None.

Supports	Beaming Length			Loads to Supports (lbs)			Accessories
	Total	Available	Required	Dead	Floor Live	Total	
1 - Stud wall - HF	5.50"	4.25"	1.75"	188	627	815	1 1/4" Rim Board
2 - Stud wall - HF	5.50"	5.50"	1.75"	188	627	815	Blocking

- Rim Board is assumed to carry all loads applied directly above it, bypassing the member being designed.
- Blocking Panels are assumed to carry no loads applied directly above them and the full load is applied to the member being designed.

Lateral Bracing	Bracing Intervals	Comments
Top Edge (Lu)	5' 3" o/c	
Bottom Edge (Lu)	23' 5" o/c	

- TJI joists are only analyzed using Maximum Allowable bracing solutions.
- Maximum allowable bracing intervals based on applied load.

Vertical Load	Location	Spacing	Dead (0.90)	Floor Live (1.00)	Comments
1 - Uniform (PSF)	0 to 23' 6"	16"	12.0	40.0	Default Load

Weyerhaeuser Notes

Weyerhaeuser warrants that the sizing of its products will be in accordance with Weyerhaeuser product design criteria and published design values. Weyerhaeuser expressly disclaims any other warranties related to the software. Use of this software is not intended to circumvent the need for a design professional as determined by the authority having jurisdiction. The designer of record, builder or framer is responsible to assure that this calculation is compatible with the overall project. Accessories (Rim Board, Blocking Panels and Squash Blocks) are not designed by this software. Products manufactured at Weyerhaeuser facilities are third-party certified to sustainable forestry standards. Weyerhaeuser Engineered Lumber Products have been evaluated by ICC-ES under evaluation reports ESR-1153 and ESR-1387 and/or tested in accordance with applicable ASTM standards. For current code evaluation reports, Weyerhaeuser product literature and installation details refer to www.weyerhaeuser.com/woodproducts/document-library.

The product application, input design loads, dimensions and support information have been provided by ForteWEB Software Operator

Forteweb Software Operator	Job Notes
dong shin D.S. Engineering PC (425) 338-4776 shin_don@hotmail.com	



Level, Floor: Joist
1 piece(s) 16" TJI® 110 @ 16" OC

Overall Length: 14' 6"

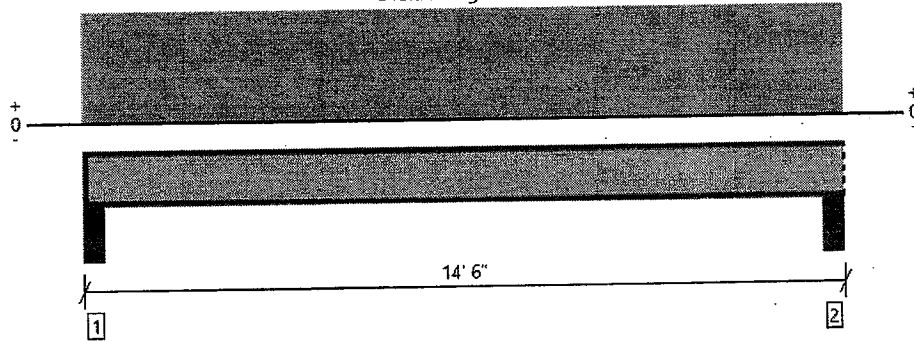

All locations are measured from the outside face of left support (or left cantilever end). All dimensions are horizontal.

Design Results	Actual @ Location	Allowed	Result	OLF	Load Combination (Pattern)
Member Reaction (lbs)	503 @ 14' 1 1/2"	1375 (3.50")	Passed (37%)	1.00	1.0 D + 1.0 L (All Spans)
Shear (lbs)	471 @ 5 1/2"	2145	Passed (22%)	1.00	1.0 D + 1.0 L (All Spans)
Moment (Ft-lbs)	1639 @ 7' 3"	4280	Passed (38%)	1.00	1.0 D + 1.0 L (All Spans)
Live Load Defl. (in)	0.082 @ 7' 3"	0.344	Passed (L/999+)	--	1.0 D + 1.0 L (All Spans)
Total Load Defl. (in)	0.106 @ 7' 3"	0.688	Passed (L/999+)	--	1.0 D + 1.0 L (All Spans)
TJ-Pro™ Rating	60	40	Passed	--	--

System : Floor
 Member Type : Joist
 Building Use : Residential
 Building Code : IBC 2018
 Design Methodology : ASD

- Deflection criteria: LL (L/480) and TL (L/240).
- Allowed moment does not reflect the adjustment for the beam stability factor.
- A structural analysis of the deck has not been performed.
- Deflection analysis is based on composite action with a single layer of 23/32" Weyerhaeuser Edge™ Panel (24" Span Rating) that is glued and nailed down.
- Additional considerations for the TJ-Pro™ Rating include: None.

Supports	Bearing Length			Loads to Supports (lbs)			Accessories
	Total	Available	Required	Dead	Floor Live	Total	
1 - Stud wall - HF	5.50"	4.25"	1.75"	116	387	503	1 1/4" Rim Board
2 - Stud wall - HF	5.50"	5.50"	1.75"	116	387	503	Blocking

- Rim Board is assumed to carry all loads applied directly above it, bypassing the member being designed.
- Blocking Panels are assumed to carry no loads applied directly above them and the full load is applied to the member being designed.

Lateral Bracing	Bracing Intervals	Comments
Top Edge (Lu)	5' 3" o/c	
Bottom Edge (Lu)	14' 5" o/c	

- TJI joists are only analyzed using Maximum Allowable bracing solutions.
- Maximum allowable bracing intervals based on applied load.

Vertical Load	Location	Spacing	Dead (0.90)	Floor Live (1.00)	Comments
1 - Uniform (PSF)	0 to 14' 6"	16"	12.0	40.0	Default Load

Weyerhaeuser Notes

Weyerhaeuser warrants that the sizing of its products will be in accordance with Weyerhaeuser product design criteria and published design values. Weyerhaeuser expressly disclaims any other warranties related to the software. Use of this software is not intended to circumvent the need for a design professional as determined by the authority having jurisdiction. The designer of record, builder or framer is responsible to assure that this calculation is compatible with the overall project. Accessories (Rim Board, Blocking Panels and Squash Blocks) are not designed by this software. Products manufactured at Weyerhaeuser facilities are third-party certified to sustainable forestry standards. Weyerhaeuser Engineered Lumber Products have been evaluated by ICC-ES under evaluation reports ESR-1153 and ESR-1387 and/or tested in accordance with applicable ASTM standards. For current code evaluation reports, Weyerhaeuser product literature and installation details refer to www.weyerhaeuser.com/woodproducts/document-library.

The product application, input design loads, dimensions and support information have been provided by ForteWEB Software Operator

ForteWEB Software Operator	Job Notes
dong shin D.S. Engineering PC (425) 338-4776 shin_don@hotmail.com	



1-3

Wood Beam

Lic. #: KW-06010224

DESCRIPTION: deck

CODE REFERENCES

Calculations per NDS 2018, IBC 2018, CBC 2019, ASCE 7-16
 Load Combination Set : IBC 2018

Material Properties

Analysis Method : Allowable Stress Design	Fb +	900 psi	E : Modulus of Elasticity	
Load Combination IBC 2018	Fb -	900 psi	Ebend-xx	1600ksi
	Fc - Prll	1350 psi	Eminbend -xx	580ksi
Wood Species : Douglas Fir-Larch	Fc - Perp	625 psi		
Wood Grade : No.2	Fv	180 psi		
	Ft	575 psi	Density	31.21pcf
Beam Bracing : Beam is Fully Braced against lateral-torsional buckling			Repetitive Member Stress Increase	

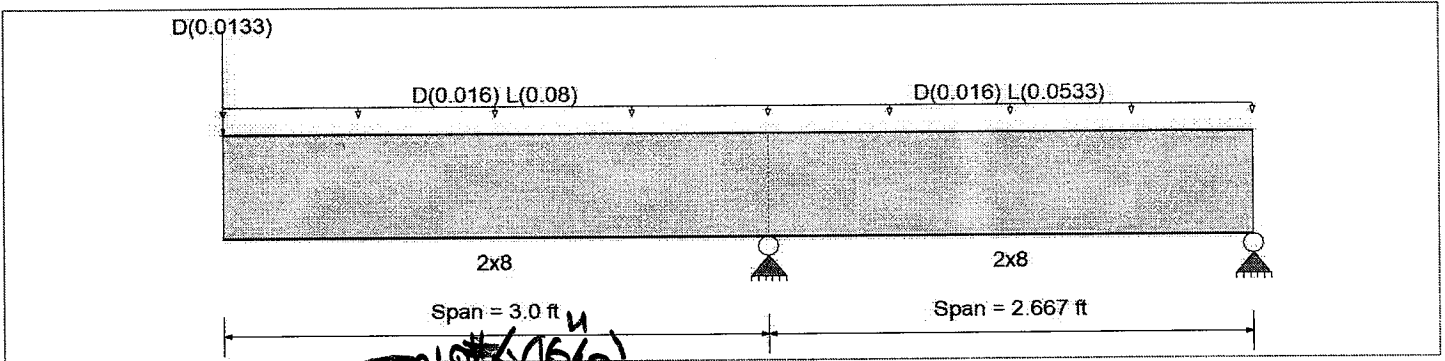

Applied Loads

Service loads entered. Load Factors will be applied for calculations.

Load for Span Number 1
 Uniform Load : D = 0.0160, L = 0.080, Tributary Width = 1.0 ft, (from deck)
 Point Load : D = 0.01330 k @ 0.0 ft, (from guardrail + misc)
 Load for Span Number 2
 Uniform Load : D = 0.0160, L = 0.05330, Tributary Width = 1.0 ft, (from floor)

DESIGN SUMMARY

Design OK

Maximum Bending Stress Ratio =	0.347 : 1	Maximum Shear Stress Ratio =	0.186 : 1
Section used for this span =	2x8	Section used for this span =	2x8
fb: Actual =	430.94 psi	fv: Actual =	33.57 psi
Fb: Allowable =	1,242.00 psi	Fv: Allowable =	180.00 psi
Load Combination =	+D+L+H	Load Combination =	+D+L+H
Location of maximum on span =	3.000ft	Location of maximum on span =	2.397 ft
Span # where maximum occurs =	Span # 1	Span # where maximum occurs =	Span # 1
Maximum Deflection			
Max Downward Transient Deflection	0.037 in Ratio = 1928 >=240		
Max Upward Transient Deflection	-0.003 in Ratio = 10651 >=240		
Max Downward Total Deflection	0.050 in Ratio = 1450 >=180		
Max Upward Total Deflection	-0.004 in Ratio = 8109 >=180		

Overall Maximum Deflections

Load Combination	Span	Max. "-" Defl	Location in Span	Load Combination	Max. "+" Defl	Location in Span
+D+L+H	1	0.0497	0.000		0.0000	0.000
	2	0.0000	0.000	+D+L+H	-0.0039	1.073

Vertical Reactions

Support notation : Far left is #1

Values in KIPS

Load Combination	Support 1	Support 2	Support 3
Overall MAXimum		0.571	-0.085
Overall MINimum		0.446	-0.021
+D+H		0.125	-0.021
+D+L+H		0.571	-0.085
+D+Lr+H		0.125	-0.021
+D+S+H		0.125	-0.021

IGNORE TO MAKE CONSERVATIVE JOIST DESIGN

Wood Beam

File: examples.ec6

Software copyright ENERCALC, INC. 1983-2020, Build:12.20.8.24

Lic. #: KW-06010224

D.S. ENGINEERING PC

DESCRIPTION: deck

Vertical Reactions

Support notation: Far left is #1

Values in KIPS

Load Combination	Support 1	Support 2	Support 3
+D+0.750Lr+0.750L+H		0.459	-0.069
+D+0.750L+0.750S+H		0.459	-0.069
+D+0.60W+H		0.125	-0.021
+D+0.70E+H		0.125	-0.021
+D+0.750Lr+0.750L+0.450W+H		0.459	-0.069
+D+0.750L+0.750S+0.450W+H		0.459	-0.069
+D+0.750L+0.750S+0.5250E+H		0.459	-0.069
+0.60D+0.60W+0.60H		0.075	-0.012
+0.60D+0.70E+0.60H		0.075	-0.012
D Only		0.125	-0.021
L Only		0.446	-0.064
H Only			

Wood Beam

Lic. #: KW-06010224

File: examples.ecb
Software copyright ENERCALC, INC. 1983-2020, Build: 12.20.8.24

D.S. ENGINEERING PC

DESCRIPTION: joist

CODE REFERENCES

Calculations per NDS 2018, IBC 2018, CBC 2019, ASCE 7-16

Load Combination Set : IBC 2018

Material Properties

Analysis Method : Allowable Stress Design
Load Combination IBC 2018

Fb + 2600 psi
Fb - 2600 psi
Fc - Prll 2510 psi
Fc - Perp 750 psi
Fv 285 psi
Ft 1555 psi

E : Modulus of Elasticity
Ebend-xx 2000 ksi
Eminbend-xx 1016.535 ksi

Wood Species : iLevel Truss Joist
Wood Grade : MicroLam LVL 2.0 E

Beam Bracing : Beam is Fully Braced against lateral-torsional buckling

Density 42.01 pcf
Repetitive Member Stress Increase

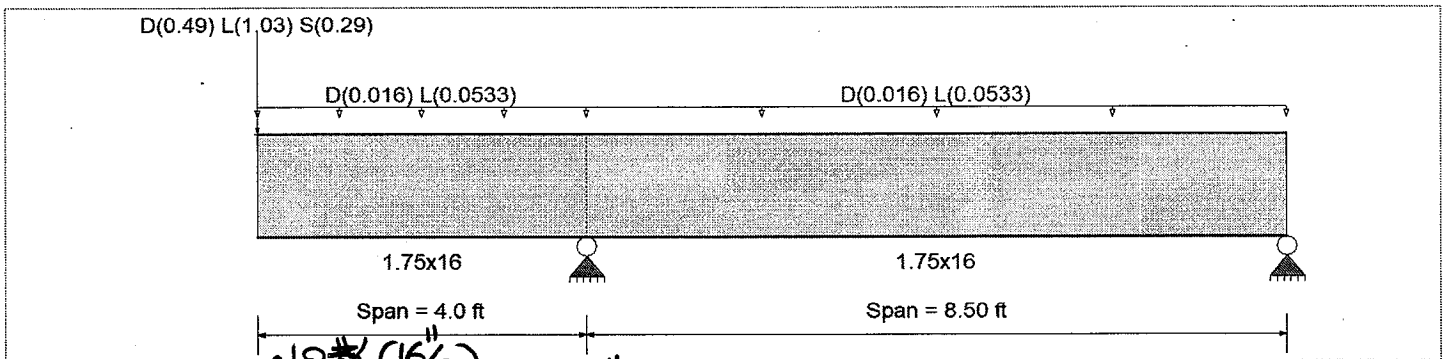

Applied Loads

Beam self weight calculated and added to loads
Load for Span Number 1

Uniform Load : D = 0.0160, L = 0.05330, Tributary Width = 1.0 ft

Point Load : D = 0.490, L = 1.030, S = 0.290 k @ 0.0 ft, (from 2nd floor + roof deck + wall)

Load for Span Number 2

Uniform Load : D = 0.0160, L = 0.05330, Tributary Width = 1.0 ft

Service loads entered. Load Factors will be applied for calculations.

$$D: [20\#(17\frac{1}{2}) + 12\#(13\frac{1}{2}) + 12\#(13\frac{1}{2})] \times 1.33$$

$$L: [60\#(17\frac{1}{2}) + 40\#(13\frac{1}{2})] \times 1.33$$

$$S: 25\#(17\frac{1}{2}) \times 1.33$$

DESIGN SUMMARY

Design OK

Maximum Bending Stress Ratio	=	0.414	1	Maximum Shear Stress Ratio	=	0.325	: 1
Section used for this span		1.75x16		Section used for this span		1.75x16	
fb: Actual	=	1,076.75	psi	fv: Actual	=	92.56	psi
Fb: Allowable	=	2,600.25	psi	Fv: Allowable	=	285.00	psi
Load Combination		+D+L		Load Combination		+D+L	
Location of maximum on span	=	4.000	ft	Location of maximum on span	=	2.682	ft
Span # where maximum occurs	=	Span # 1		Span # where maximum occurs	=	Span # 1	
Maximum Deflection							
Max Downward Transient Deflection		0.101	in	Ratio =		950	>=360
Max Upward Transient Deflection		-0.026	in	Ratio =		3950	>=360
Max Downward Total Deflection		0.149	in	Ratio =		644	>=240
Max Upward Total Deflection		-0.038	in	Ratio =		2673	>=240

Overall Maximum Deflections

Load Combination	Span	Max. "-" Defl	Location in Span	Load Combination	Max. "+" Defl	Location in Span
+D+L	1	0.1491	0.000		0.0000	0.000
	2	0.0000	0.000	+D+L	-0.0381	3.466

Vertical Reactions

Support notation : Far left is #1

Values in KIPS

Load Combination	Support 1	Support 2	Support 3
Overall MAXimum		2.947	-0.484
Overall MINimum		0.426	-0.151
D Only		0.943	-0.151
+D+L		2.947	-0.459
+D+S		1.369	-0.287

Wood Beam

File: examples.ec6

Software copyright ENERCALC, INC. 1983-2020, Build:12.20.8.24

Lic. # : KW-06010224

D.S. ENGINEERING PC

DESCRIPTION: joist

Vertical Reactions

Support notation : Far left is #1

Values in KIPS

Load Combination	Support 1	Support 2	Support 3
+D+0.750L		2.446	-0.382
+D+0.750L+0.750S		2.766	-0.484
+0.60D		0.566	-0.090
L Only		2.005	-0.308
S Only		0.426	-0.136

Wood Beam

Lic. #: KW-06010224

DESCRIPTION: header (F16)

CODE REFERENCES

Calculations per NDS 2018, IBC 2018, CBC 2019, ASCE 7-16

Load Combination Set : IBC 2018

Material Properties

Analysis Method : Allowable Stress Design
 Load Combination IBC 2018

Fb +	2400 psi	E : Modulus of Elasticity	
Fb -	1850 psi	Ebend- xx	1800 ksi
Fc - Prll	1650 psi	Eminbend - xx	950 ksi
Fc - Perp	650 psi	Ebend- yy	1600 ksi
Fv	265 psi	Eminbend - yy	850 ksi
Ft	1100 psi	Density	31.21pcf

Wood Species : DF/DF
 Wood Grade : 24F-V4

Beam Bracing : Completely Unbraced

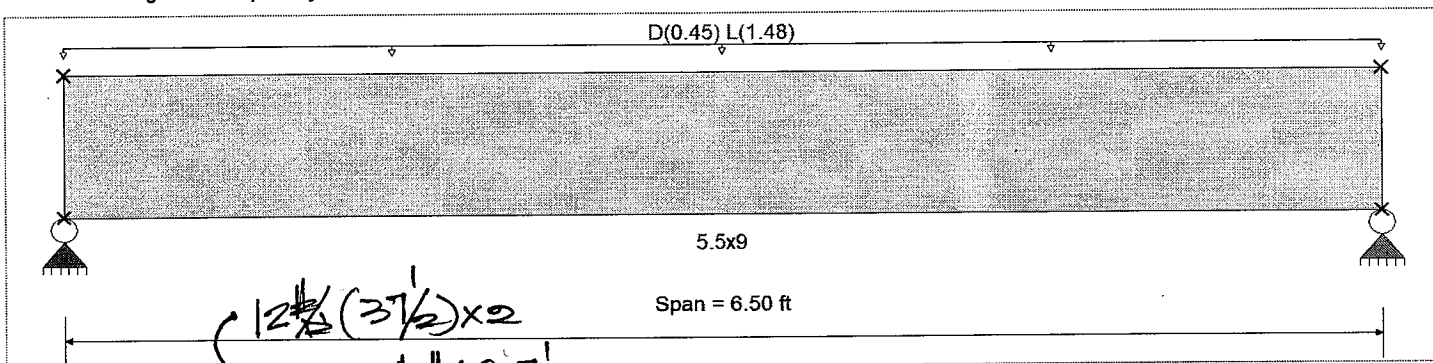

Applied Loads

Service loads entered. Load Factors will be applied for calculations.

Beam self weight calculated and added to loads

Uniform Load : D = 0.450, L = 1.480, Tributary Width = 1.0 ft

DESIGN SUMMARY

Design OK

Maximum Bending Stress Ratio	=	0.694	1	Maximum Shear Stress Ratio	=	0.558	: 1
Section used for this span		5.5x9		Section used for this span		5.5x9	
fb: Actual	=	1,656.48 psi		fv: Actual	=	147.88 psi	
Fb: Allowable	=	2,387.32 psi		Fv: Allowable	=	265.00 psi	
Load Combination		+D+L		Load Combination		+D+L	
Location of maximum on span	=	3.250 ft		Location of maximum on span	=	5.765 ft	
Span # where maximum occurs	=	Span # 1		Span # where maximum occurs	=	Span # 1	
Maximum Deflection							
Max Downward Transient Deflection		0.099 in	Ratio = 784 >= 360				
Max Upward Transient Deflection		0.000 in	Ratio = 0 < 360				
Max Downward Total Deflection		0.130 in	Ratio = 598 >= 240				
Max Upward Total Deflection		0.000 in	Ratio = 0 < 240				

Overall Maximum Deflections

Load Combination	Span	Max. "+" Defl	Location in Span	Load Combination	Max. "+" Defl	Location in Span
+D+L	1	0.1304	3.274		0.0000	0.000

Vertical Reactions

Support notation : Far left is #1

Values in KIPS

Load Combination	Support 1	Support 2
Overall MAXimum	6.307	6.307
Overall MINimum	4.810	4.810
D Only	1.497	1.497
+D+L	6.307	6.307
+D+0.750L	5.105	5.105
+0.60D	0.898	0.898
L Only	4.810	4.810

Wood Beam

Lic. #: KW-06010224

DESCRIPTION: header (F17)

CODE REFERENCES

Calculations per NDS 2018, IBC 2018, CBC 2019, ASCE 7-16
Load Combination Set : IBC 2018

Material Properties

Analysis Method : Allowable Stress Design	Fb +	875 psi	E : Modulus of Elasticity	
Load Combination IBC 2018	Fb -	875 psi	Ebend- xx	1300ksi
	Fc - Prll	600 psi	Eminbend - xx	470ksi
Wood Species : Douglas Fir-Larch	Fc - Perp	625 psi		
Wood Grade : No.2	Fv	170 psi		
	Ft	425 psi	Density	31.21 pcf
Beam Bracing : Completely Unbraced				

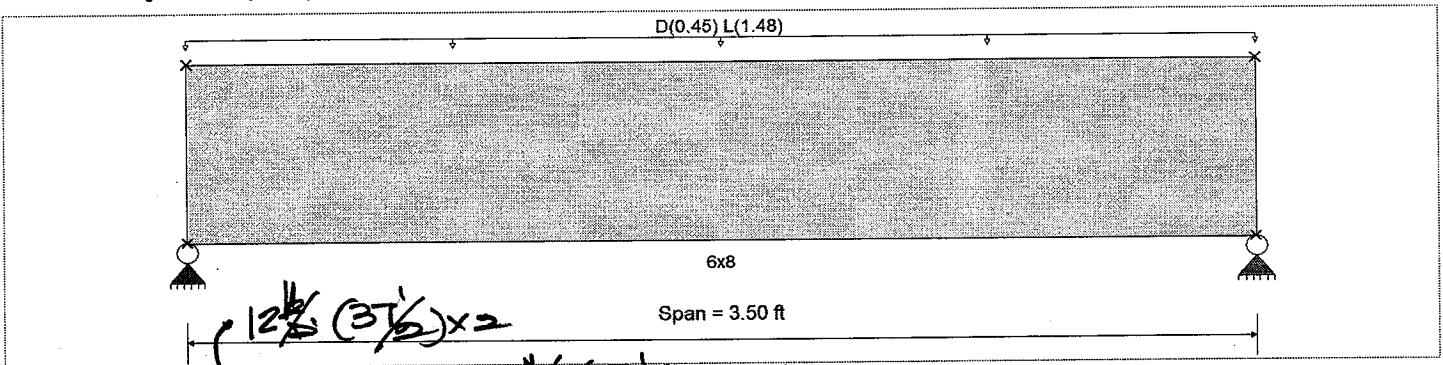

Applied Loads

Beam self weight calculated and added to loads

Uniform Load : D = 0.450, L = 1.480, Tributary Width = 1.0 ft

Service loads entered. Load Factors will be applied for calculations.

DESIGN SUMMARY

Design OK

Maximum Bending Stress Ratio	=	0.791 : 1	Maximum Shear Stress Ratio	=	0.472 : 1
Section used for this span		6x8	Section used for this span		6x8
fb: Actual	=	690.97 psi	fv: Actual	=	80.16 psi
Fb: Allowable	=	873.50 psi	Fv: Allowable	=	170.00 psi
Load Combination		+D+L	Load Combination		+D+L
Location of maximum on span	=	1.750 ft	Location of maximum on span	=	2.887 ft
Span # where maximum occurs	=	Span # 1	Span # where maximum occurs	=	Span # 1
Maximum Deflection					
Max Downward Transient Deflection		0.020 in Ratio = 2100 >= 360			
Max Upward Transient Deflection		0.000 in Ratio = 0 < 360			
Max Downward Total Deflection		0.026 in Ratio = 1603 >= 240			
Max Upward Total Deflection		0.000 in Ratio = 0 < 240			

Overall Maximum Deflections

Load Combination	Span	Max. "-" Defl	Location in Span	Load Combination	Max. "+" Defl	Location in Span
+D+L	1	0.0262	1.763		0.0000	0.000

Vertical Reactions

Support notation : Far left is #1

Values in KIPS

Load Combination	Support 1	Support 2
Overall MAXimum	3.393	3.393
Overall MINimum	2.590	2.590
D Only	0.803	0.803
+D+L	3.393	3.393
+D+0.750L	2.746	2.746
+0.60D	0.482	0.482
L Only	2.590	2.590

Steel Beam

Project File: ENERCALC_20

LIC#: KW-06015335, Build:20.22.4.26

D.S. ENGINEERING PC

(c) ENERCALC INC 1983-2022

DESCRIPTION: beam (F18)

CODE REFERENCES

Calculations per AISC 360-16, IBC 2018, CBC 2019, ASCE 7-16
Load Combination Set : IBC 2018

Material Properties

Analysis Method : Allowable Strength Design
Beam Bracing : Beam is Fully Braced against lateral-torsional buckling
Bending Axis : Major Axis Bending

Fy : Steel Yield : 50.0 ksi
E : Modulus : 29,000.0 ksi

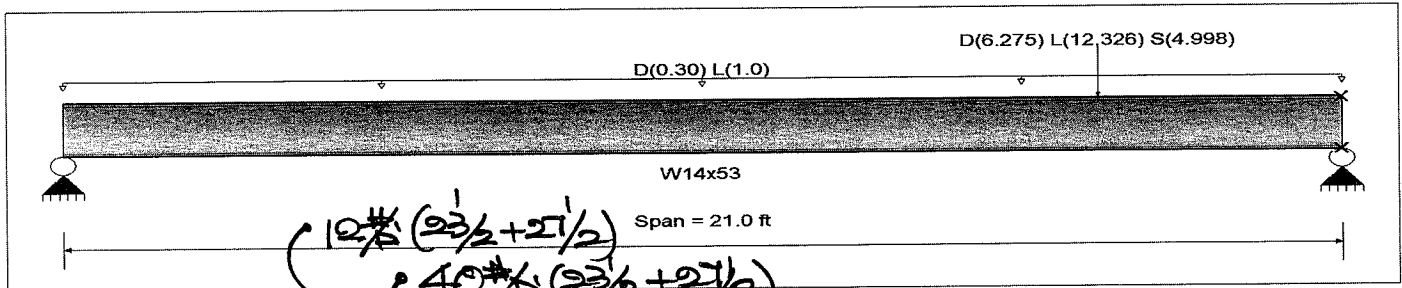

Applied Loads

Beam self weight calculated and added to loading
Uniform Load : D = 0.30, L = 1.0 k/ft, Tributary Width = 1.0 ft, (from 1st + 2nd floor)
Point Load : D = 6.275, L = 12.326, S = 4.998 k @ 17.0 ft, (from (R3))

Service loads entered. Load Factors will be applied for calculations.

DESIGN SUMMARY

Design OK

Maximum Bending Stress Ratio =	0.536 : 1	Maximum Shear Stress Ratio =	0.285 : 1
Section used for this span	W14x53	Section used for this span	W14x53
Ma : Applied	116.425 k-ft	Va : Applied	29.264 k
Mn / Omega : Allowable	217.315 k-ft	Vn/Omega : Allowable	102.860 k
Load Combination	+D+L	Load Combination	+D+L
Span # where maximum occurs	Span # 1	Location of maximum on span	21.000 ft
Span # where maximum occurs	Span # 1	Span # where maximum occurs	Span # 1
Maximum Deflection			
Max Downward Transient Deflection	0.424 in Ratio = 594	>=360	
Max Upward Transient Deflection	0.000 in Ratio = 0	<360	Span: 1 : L Only
Max Downward Total Deflection	0.596 in Ratio = 423	>=240.	Span: 1 : +D+L
Max Upward Total Deflection	0.000 in Ratio = 0	<240.0	

Maximum Forces & Stresses for Load Combinations

Load Combination	Segment Length	Span #	Max Stress Ratios		Summary of Moment Values						Summary of Shear Values				
			M	V	Mmax +	Mmax -	Ma Max	Mnx	Mnx/Omega	Cb	Rm	Va Max	Vnx	Vnx/Omega	
D Only															
Dsgn. L = 21.00 ft	21.00 ft	1	0.157	0.085	34.03			34.03	362.92	217.32	1.00	1.00	8.79	154.29	102.86
+D+L															
Dsgn. L = 21.00 ft	21.00 ft	1	0.536	0.285	116.42			116.42	362.92	217.32	1.00	1.00	29.26	154.29	102.86
+D+S															
Dsgn. L = 21.00 ft	21.00 ft	1	0.223	0.125	48.54			48.54	362.92	217.32	1.00	1.00	12.83	154.29	102.86
+D+0.750L															
Dsgn. L = 21.00 ft	21.00 ft	1	0.441	0.235	95.80			95.80	362.92	217.32	1.00	1.00	24.14	154.29	102.86
+D+0.750L+0.750S															
Dsgn. L = 21.00 ft	21.00 ft	1	0.485	0.264	105.44			105.44	362.92	217.32	1.00	1.00	27.18	154.29	102.86
+0.60D															
Dsgn. L = 21.00 ft	21.00 ft	1	0.094	0.051	20.42			20.42	362.92	217.32	1.00	1.00	5.27	154.29	102.86

Overall Maximum Deflections

Load Combination	Span	Max. "-" Defl	Location in Span	Load Combination	Max. "+" Defl	Location in Span
+D+L	1	0.5964	11.040		0.0000	0.000

Vertical Reactions

Load Combination	Support 1	Support 2
Overall MAXimum	17.750	29.264

Support notation : Far left is #

Values in KIPS

00413

1-10

Steel Beam

Project File: ENERCALC_20

LIC# : KW-06015335, Build:20.22.4.26

D.S. ENGINEERING PC

(c) ENERCALC INC 1983-2022

DESCRIPTION: beam (F18)**Vertical Reactions**

Support notation : Far left is #

Values in KIPS

Load Combination	Support 1	Support 2
Overall MINimum	0.952	4.046
D Only	4.902	8.786
+D+L	17.750	29.264
+D+S	5.854	12.832
+D+0.750L	14.538	24.145
+D+0.750L+0.750S	15.252	27.179
+0.60D	2.941	5.272
L Only	12.848	20.478
S Only	0.952	4.046

Steel Section Properties : W14x53

Depth	=	13.900 in	I xx	=	541.00 in ⁴	J	=	1.940 in ⁴
Web Thick	=	0.370 in	S xx	=	77.80 in ³	Cw	=	2,540.00 in ⁶
Flange Width	=	8.060 in	R xx	=	5.890 in			
Flange Thick	=	0.660 in	Zx	=	87.100 in ³			
Area	=	15.600 in ²	I yy	=	57.700 in ⁴	Wno	=	26.700 in ²
Weight	=	53.000 plf	S yy	=	14.300 in ³	Sw	=	35.500 in ⁴
Kdesign	=	1.250 in	R yy	=	1.920 in	Qf	=	16.800 in ³
K1	=	1.000 in	Zy	=	22.000 in ³	Qw	=	42.500 in ³
rts	=	2.220 in						
Ycg	=	6.950 in						

Steel Beam

Project File: ENERCALC_20

LIC#: KW-06015335, Build:20.22.4.26

D.S. ENGINEERING PC

(c) ENERCALC INC 1983-2022

DESCRIPTION: beam (F19)

CODE REFERENCES

Calculations per AISC 360-16, IBC 2018, CBC 2019, ASCE 7-16

Load Combination Set : IBC 2018

Material Properties

Analysis Method : Allowable Strength Design

Fy : Steel Yield : 50.0 ksi

Beam Bracing : Beam is Fully Braced against lateral-torsional buckling

E : Modulus : 29,000.0 ksi

Bending Axis : Major Axis Bending

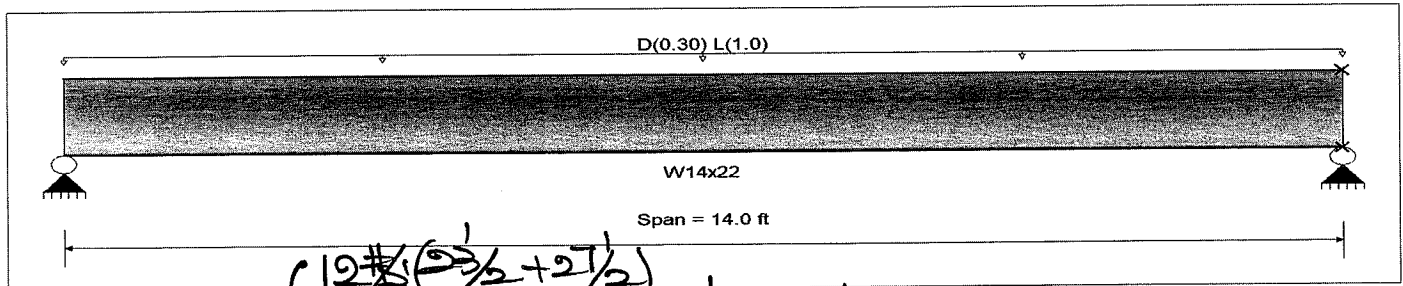

Applied Loads

Beam self weight calculated and added to loading
 Uniform Load : D = 0.30, L = 1.0 k/ft, Tributary Width = 1.0 ft, (from 1st + 2nd floor)

Service loads entered. Load Factors will be applied for calculations.

DESIGN SUMMARY

Design OK

Maximum Bending Stress Ratio =	0.391 : 1	Maximum Shear Stress Ratio =	0.147 : 1
Section used for this span	W14x22	Section used for this span	W14x22
Ma : Applied	32.389 k-ft	Va : Applied	9.254 k
Mn / Omega : Allowable	82.834 k-ft	Vn/Omega : Allowable	63.020 k
Load Combination	+D+L	Load Combination	+D+L
Span # where maximum occurs	Span # 1	Location of maximum on span	0.000 ft
Span # where maximum occurs	Span # 1	Span # where maximum occurs	Span # 1
Maximum Deflection			
Max Downward Transient Deflection	0.150 in Ratio = 1,116	>=360	
Max Upward Transient Deflection	0.000 in Ratio = 0	<360	Span: 1 : L Only
Max Downward Total Deflection	0.199 in Ratio = 845	>=240	Span: 1 : +D+L
Max Upward Total Deflection	0.000 in Ratio = 0	<240.0	

Maximum Forces & Stresses for Load Combinations

Load Combination	Segment Length	Span #	Max Stress Ratios		Summary of Moment Values						Summary of Shear Values			
			M	V	Mmax +	Mmax -	Ma Max	Mnx	Mnx/Omega	Cb	Rm	Va Max	Vnx/Vnx/Omega	
D Only														
Dsgn. L = 14.00 ft		1	0.095	0.036	7.89		7.89	138.33	82.83	1.00	1.00	2.25	94.53	63.02
+D+L														
Dsgn. L = 14.00 ft		1	0.391	0.147	32.39		32.39	138.33	82.83	1.00	1.00	9.25	94.53	63.02
+D+0.750L														
Dsgn. L = 14.00 ft		1	0.317	0.119	26.26		26.26	138.33	82.83	1.00	1.00	7.50	94.53	63.02
+0.60D														
Dsgn. L = 14.00 ft		1	0.057	0.021	4.73		4.73	138.33	82.83	1.00	1.00	1.35	94.53	63.02

Overall Maximum Deflections

Load Combination	Span	Max. "-" Defl	Location in Span	Load Combination	Max. "+" Defl	Location in Span
+D+L	1	0.1989	7.040		0.0000	0.000

Vertical Reactions

Load Combination	Support notation : Far left is #	
	Support 1	Support 2
Overall MAXimum	9.254	9.254
Overall MINimum	1.352	1.352
D Only	2.254	2.254
+D+L	9.254	9.254
+D+0.750L	7.504	7.504
+0.60D	1.352	1.352
L Only	7.000	7.000

Steel Beam

Project File: ENERCALC_20

LIC# : KW-06015335, Build:20.22.4.26

D.S. ENGINEERING PC

(c) ENERCALC INC 1983-2022

DESCRIPTION: beam (F19)**Steel Section Properties : W14x22**

Depth	=	13.700 in	I xx	=	199.00 in ⁴	J	=	0.208 in ⁴
Web Thick	=	0.230 in	S xx	=	29.00 in ³	Cw	=	314.00 in ⁶
Flange Width	=	5.000 in	R xx	=	5.540 in			
Flange Thick	=	0.335 in	Zx	=	33.200 in ³			
Area	=	6.490 in ²	I yy	=	7.000 in ⁴			
Weight	=	22.000 plf	S yy	=	2.800 in ³	Wno	=	16.700 in ²
Kdesign	=	0.735 in	R yy	=	1.040 in	Sw	=	7.000 in ⁴
K1	=	0.750 in	Zy	=	4.390 in ³	Qf	=	5.340 in ³
rts	=	1.270 in				Qw	=	16.100 in ³
Ycg	=	6.850 in						

Steel Beam

Project File: ENERCALC_20

LIC#: KW-06015335, Build:20.22.4.26

D.S. ENGINEERING PC

(c) ENERCALC INC 1983-2022

DESCRIPTION: header (F20) : garage door

CODE REFERENCES

Calculations per AISC 360-16, IBC 2018, CBC 2019, ASCE 7-16

Load Combination Set : IBC 2018

Material Properties

Analysis Method : Allowable Strength Design

Beam Bracing : Beam is Fully Braced against lateral-torsional buckling

Bending Axis : Major Axis Bending

Fy : Steel Yield : 50.0 ksi

E : Modulus : 29,000.0 ksi

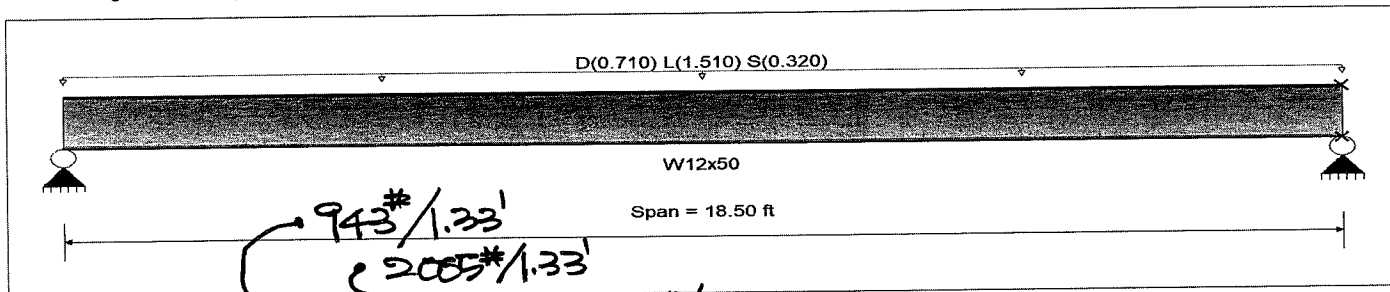

Applied Loads

Beam self weight calculated and added to loading

Uniform Load : D = 0.710, L = 1.510, S = 0.320 k/ft, Tributary Width = 1.0 ft, (from 1.75x16 LVL)

Service loads entered. Load Factors will be applied for calculations.

DESIGN SUMMARY

Design OK

Maximum Bending Stress Ratio =	0.541 : 1	Maximum Shear Stress Ratio =	0.233 : 1
Section used for this span	W12x50	Section used for this span	W12x50
Ma : Applied	97.113 k-ft	Va : Applied	20.998 k
Mn / Omega : Allowable	179.391 k-ft	Vn/Omega : Allowable	90.280 k
Load Combination	+D+L	Load Combination	+D+L
Span # where maximum occurs	Span # 1	Location of maximum on span	0.000 ft
Span # where maximum occurs	Span # 1	Span # where maximum occurs	Span # 1
Maximum Deflection			
Max Downward Transient Deflection	0.352 in Ratio = 629	>=360	
Max Upward Transient Deflection	0.000 in Ratio = 0	<360	Span: 1 : L Only
Max Downward Total Deflection	0.530 in Ratio = 419	>=240.	Span: 1 : +D+L
Max Upward Total Deflection	0.000 in Ratio = 0	<240.0	

Maximum Forces & Stresses for Load Combinations

Load Combination	Segment Length	Span #	Max Stress Ratios		Summary of Moment Values					Summary of Shear Values				
			M	V	Mmax +	Mmax -	Ma Max	Mnx	Mnx/Omega	Cb	Rm	Va Max	Vnx/Vnx/Omega	
D Only														
Dsgn. L =	18.50 ft	1	0.181	0.078	32.51		32.51	299.58	179.39	1.00	1.00	7.03	135.42	90.28
+D+L														
Dsgn. L =	18.50 ft	1	0.541	0.233	97.11		97.11	299.58	179.39	1.00	1.00	21.00	135.42	90.28
+D+S														
Dsgn. L =	18.50 ft	1	0.258	0.111	46.20		46.20	299.58	179.39	1.00	1.00	9.99	135.42	90.28
+D+0.750L														
Dsgn. L =	18.50 ft	1	0.451	0.194	80.96		80.96	299.58	179.39	1.00	1.00	17.51	135.42	90.28
+D+0.750L+0.750S														
Dsgn. L =	18.50 ft	1	0.509	0.218	91.23		91.23	299.58	179.39	1.00	1.00	19.73	135.42	90.28
+0.60D														
Dsgn. L =	18.50 ft	1	0.109	0.047	19.51		19.51	299.58	179.39	1.00	1.00	4.22	135.42	90.28

Overall Maximum Deflections

Load Combination	Span	Max. "-" Defl	Location in Span	Load Combination	Max. "+" Defl	Location in Span
+D+L	1	0.5300	9.303		0.0000	0.000

Vertical Reactions

Support notation : Far left is #

Values in KIPS

Load Combination	Support 1	Support 2
Overall MAXimum	20.998	20.998
Overall MINimum	2.960	2.960
D Only	7.030	7.030

00417

1-14

Steel Beam

Project File: ENERCALC_20

LIC#: KW-06015335, Build:20.22.4.26

D.S. ENGINEERING PC

(c) ENERCALC INC 1983-2022

DESCRIPTION: header (F20) : garage door**Vertical Reactions**

Support notation : Far left is #

Values in KIPS

Load Combination	Support 1	Support 2
+D+L	20.998	20.998
+D+S	9.990	9.990
+D+0.750L	17.506	17.506
+D+0.750L+0.750S	19.726	19.726
+0.60D	4.218	4.218
L Only	13.968	13.968
S Only	2.960	2.960

Steel Section Properties : W12x50

Depth	=	12.200 in	I xx	=	391.00 in ⁴	J	=	1.710 in ⁴
Web Thick	=	0.370 in	S xx	=	64.20 in ³	Cw	=	1,880.00 in ⁶
Flange Width	=	8.080 in	R xx	=	5.180 in			
Flange Thick	=	0.640 in	Zx	=	71.900 in ³			
Area	=	14.600 in ²	I yy	=	56.300 in ⁴			
Weight	=	50.000 plf	S yy	=	13.900 in ³	Wno	=	23.400 in ²
Kdesign	=	1.140 in	R yy	=	1.960 in	Sw	=	30.200 in ⁴
K1	=	0.938 in	Zy	=	21.300 in ³	Qf	=	14.300 in ³
rts	=	2.250 in				Qw	=	35.400 in ³
Ycg	=	6.100 in						

Wood Beam

Lic. #: KW-06010224

DESCRIPTION: header (F21)

CODE REFERENCES

Calculations per NDS 2018, IBC 2018, CBC 2019, ASCE 7-16

Load Combination Set : IBC 2018

Material Properties

Analysis Method : Allowable Stress Design
 Load Combination IBC 2018

Fb +	2400 psi	E : Modulus of Elasticity	
Fb -	1850 psi	Ebend- xx	1800 ksi
Fc - Prll	1650 psi	Eminbend - xx	950 ksi
Fc - Perp	650 psi	Ebend- yy	1600 ksi
Fv	265 psi	Eminbend - yy	850 ksi
Ft	1100 psi	Density	31.21 pcf

Wood Species : DF/DF
 Wood Grade : 24F-V4

Beam Bracing : Completely Unbraced

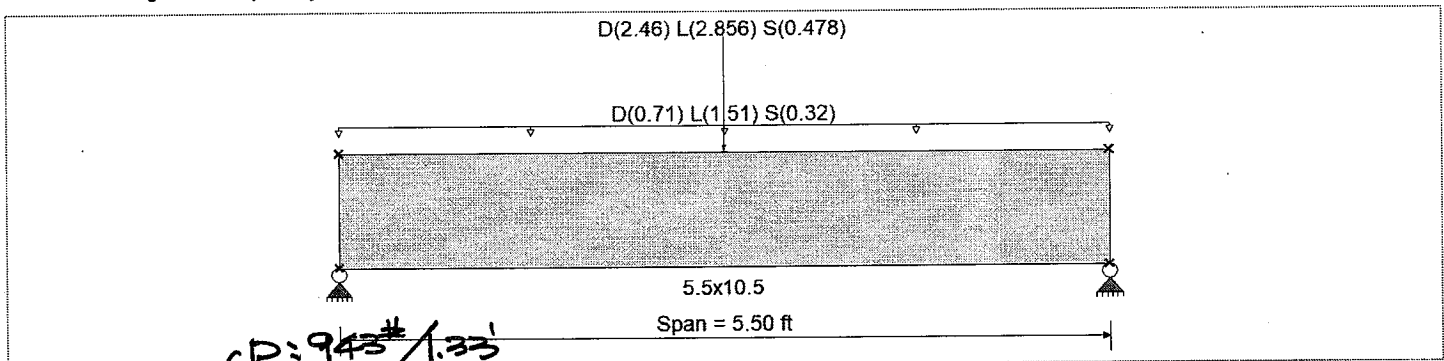

Applied Loads

Service loads entered. Load Factors will be applied for calculations.

Beam self weight calculated and added to loads

Uniform Load : D = 0.710, L = 1.510, S = 0.320, Tributary Width = 1.0 ft

Point Load : D = 2.460, L = 2.856, S = 0.4780 k @ 2.750 ft, (from (F11))

Handwritten notes: D = 945# / 1.33', L = 2005# / 1.33', 426# / 1.33' (FROM 1.75 x 16 LVL Joist)

DESIGN SUMMARY

Design OK

Maximum Bending Stress Ratio	=	0.784	1	Maximum Shear Stress Ratio	=	0.673	: 1
Section used for this span		5.5x10.5		Section used for this span		5.5x10.5	
fb: Actual	=	1,870.27	psi	fv: Actual	=	178.45	psi
Fb: Allowable	=	2,386.91	psi	Fv: Allowable	=	265.00	psi
Load Combination		+D+L		Load Combination		+D+L	
Location of maximum on span	=	2.750	ft	Location of maximum on span	=	4.637	ft
Span # where maximum occurs	=	Span # 1		Span # where maximum occurs	=	Span # 1	
Maximum Deflection							
Max Downward Transient Deflection		0.051	in	Ratio =		1300	>=360
Max Upward Transient Deflection		0.000	in	Ratio =		0	<360
Max Downward Total Deflection		0.082	in	Ratio =		805	>=240
Max Upward Total Deflection		0.000	in	Ratio =		0	<240

Overall Maximum Deflections

Load Combination	Span	Max. "-" Defl	Location in Span	Load Combination	Max. "+" Defl	Location in Span
+D+L	1	0.0819	2.770		0.0000	0.000

Vertical Reactions

Support notation : Far left is #1

Values in KIPS

Load Combination	Support 1	Support 2
Overall MAXimum	8.797	8.797
Overall MINimum	1.119	1.119
D Only	3.217	3.217
+D+L	8.797	8.797
+D+S	4.336	4.336
+D+0.750L	7.402	7.402
+D+0.750L+0.750S	8.242	8.242
+0.60D	1.930	1.930
L Only	5.581	5.581

Wood Beam

File: examples.ec6
Software copyright ENERCALC, INC. 1983-2020, Build: 12.20.8.24
D.S. ENGINEERING PC

Lic. #: KW-06010224

DESCRIPTION: header (F21)

Vertical Reactions

Support notation : Far left is #1

Values in KIPS

Load Combination	Support 1	Support 2
S Only	1.119	1.119

Wood Beam

Lic. #: KW-06010224

DESCRIPTION: header (F22)

CODE REFERENCES

Calculations per NDS 2018, IBC 2018, CBC 2019, ASCE 7-16
Load Combination Set : IBC 2018

Material Properties

Analysis Method : Allowable Stress Design
Load Combination IBC 2018

Wood Species : DF/DF
Wood Grade : 24F-V4

Beam Bracing : Completely Unbraced

Fb +	2,400.0 psi	E : Modulus of Elasticity	
Fb -	1,850.0 psi	Ebend-xx	1,800.0 ksi
Fc - Prll	1,650.0 psi	Eminbend - xx	950.0 ksi
Fc - Perp	650.0 psi	Ebend-yy	1,600.0 ksi
Fv	265.0 psi	Eminbend - yy	850.0 ksi
Ft	1,100.0 psi	Density	31.210 pcf

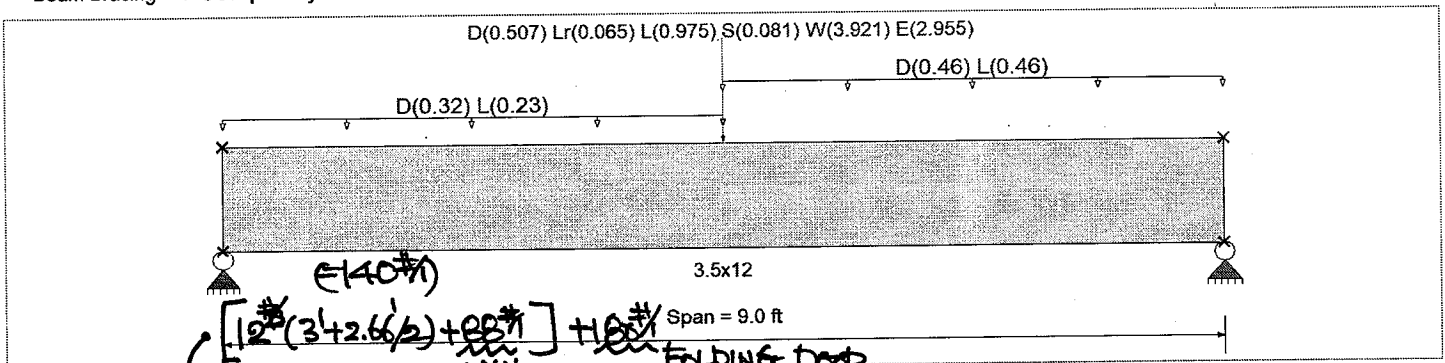

Applied Loads

Service loads entered. Load Factors will be applied for calculations.

Beam self weight calculated and added to loads
Load for Span Number 1

Uniform Load : D = 0.320, L = 0.230 k/ft, Extent = 0.0 -> 4.50 ft, Tributary Width = 1.0 ft
Point Load : D = 0.5070, Lr = 0.0650, L = 0.9750, S = 0.0810, W = 3.921, E = 2.955 k @ 4.50 ft, (from shearwall Calc & header (F13))
Uniform Load : D = 0.460, L = 0.460 k/ft, Extent = 4.50 -> 9.0 ft, Tributary Width = 1.0 ft

DESIGN SUMMARY

Maximum Bending Stress Ratio	=	0.671 : 1	Maximum Shear Stress Ratio	=	0.484 : 1
Section used for this span	=	3.5x12	Section used for this span	=	3.5x12
fb: Actual	=	1,552.65 psi	fv: Actual	=	128.22 psi
Fb: Allowable	=	2,315.51 psi	Fv: Allowable	=	265.00 psi
Load Combination	=	+D+L	Load Combination	=	+D+L
Location of maximum on span	=	4.500 ft	Location of maximum on span	=	8.015 ft
Span # where maximum occurs	=	Span # 1	Span # where maximum occurs	=	Span # 1
Maximum Deflection					
Max Downward Transient Deflection		0.114 in Ratio = 946 >= 360			
Max Upward Transient Deflection		0.000 in Ratio = 0 < 360			
Max Downward Total Deflection		0.197 in Ratio = 548 >= 240			
Max Upward Total Deflection		0.000 in Ratio = 0 < 240			

Overall Maximum Deflections

Load Combination	Span	Max. "-" Defl	Location in Span	Load Combination	Max. "+" Defl	Location in Span
+D+0.750L+0.750S+0.450W	1	0.1968	4.566		0.0000	0.000

Vertical Reactions

Load Combination	Support notation : Far left is #1	
	Support 1	Support 2
Overall MAXimum	4.141	4.844
Overall MINimum	1.478	1.478
D Only	1.892	2.207
+D+L	3.673	4.506
+D+Lr	1.924	2.239
+D+S	1.932	2.247
+D+0.750Lr+0.750L	3.252	3.955

Handwritten notes: 'HUCAD' W/ (18) - 1/4 x 1 3/4
TITEN TURBO
(4920*)

Wood BeamFile: examples.ec6
Software copyright ENERCALC, INC. 1983-2020, Build:12.20.8.24
D.S. ENGINEERING PC

Lic. #: KW-06010224

DESCRIPTION: header (F22)

Vertical Reactions

Support notation : Far left is #1

Values in KIPS

Load Combination	Support 1	Support 2
+D+0.750L+0.750S	3.258	3.961
+D+0.60W	3.068	3.383
+D+0.70E	2.926	3.241
+D+0.750Lr+0.750L+0.450W	4.135	4.838
+D+0.750L+0.750S+0.450W	4.141	4.844
+D+0.750L+0.750S+0.5250E	4.034	4.737
+0.60D+0.60W	2.311	2.500
+0.60D+0.70E	2.169	2.358
Lr Only	0.033	0.033
L Only	1.781	2.299
S Only	0.041	0.041
W Only	1.961	1.961
E Only	1.478	1.478

Level, Floor: Joist
1 piece(s) 16" TJI@ 110 @ 12" OC

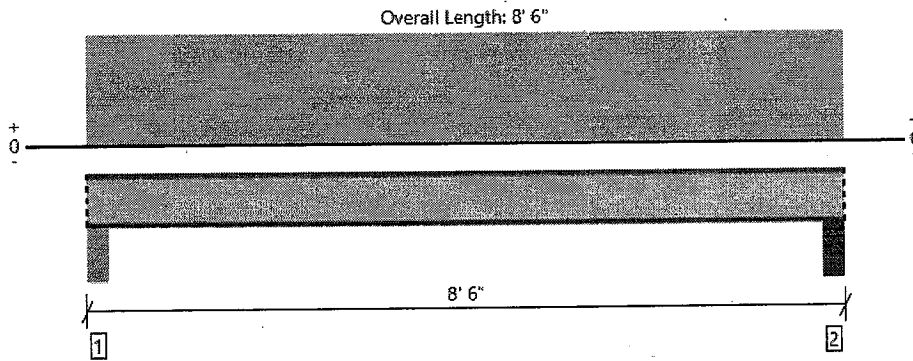

All locations are measured from the outside face of left support (or left cantilever end). All dimensions are horizontal.

Design Results	Actual @ Location	Allowed	Result	LDf	Load: Combination (Pattern)
Member Reaction (lbs)	553 @ 4 1/2"	1375 (3.50")	Passed (40%)	1.00	1.0 D + 1.0 L (All Spans)
Shear (lbs)	493 @ 5 1/2"	2145	Passed (23%)	1.00	1.0 D + 1.0 L (All Spans)
Moment (Ft-lbs)	976 @ 4' 3"	4280	Passed (23%)	1.00	1.0 D + 1.0 L (All Spans)
Live Load Defl. (in)	0.023 @ 4' 3"	0.194	Passed (L/999+)	--	1.0 D + 1.0 L (All Spans)
Total Load Defl. (in)	0.030 @ 4' 3"	0.387	Passed (L/999+)	--	1.0 D + 1.0 L (All Spans)
TJ-Pro™ Rating	70	40	Passed	--	--

System : Floor
 Member Type : Joist
 Building Use : Residential
 Building Code : IBC 2018
 Design Methodology : ASD

- Deflection criteria: LL (L/480) and TL (L/240).
- Allowed moment does not reflect the adjustment for the beam stability factor.
- A structural analysis of the deck has not been performed.
- Deflection analysis is based on composite action with a single layer of 23/32" Weyerhaeuser Edge™ Panel (24" Span Rating) that is glued and nailed down.
- Additional considerations for the TJ-Pro™ Rating include: None.

Supports	Bearing Length			Loads to Supports (lbs)			Accessories
	Total	Available	Required	Dead	Floor Live	Total	
1 - Beam - PSL	5.50"	5.50"	1.75"	128	425	553	Blocking
2 - Stud wall - HF	5.50"	5.50"	1.75"	128	425	553	Blocking

• Blocking Panels are assumed to carry no loads applied directly above them and the full load is applied to the member being designed.

Lateral Bracing	Bracing Intervals	Comments
Top Edge (Lu)	6' 11" o/c	
Bottom Edge (Lu)	8' 6" o/c	

- TJI joists are only analyzed using Maximum Allowable bracing solutions.
- Maximum allowable bracing intervals based on applied load.

Handwritten notes: 12 #1 (5/2) 40 #1 (5/2)

Vertical Load	Location	Spacing	Dead (0.90)	Floor Live (1.00)	Comments
1 - Uniform (PLF)	0 to 8' 6"	N/A	30.0	100.0	Default Load

Weyerhaeuser Notes

Weyerhaeuser warrants that the sizing of its products will be in accordance with Weyerhaeuser product design criteria and published design values. Weyerhaeuser expressly disclaims any other warranties related to the software. Use of this software is not intended to circumvent the need for a design professional as determined by the authority having jurisdiction. The designer of record, builder or framer is responsible to assure that this calculation is compatible with the overall project. Accessories (Rim Board, Blocking Panels and Squash Blocks) are not designed by this software. Products manufactured at Weyerhaeuser facilities are third-party certified to sustainable forestry standards. Weyerhaeuser Engineered Lumber Products have been evaluated by ICC-ES under evaluation reports ESR-1153 and ESR-1387 and/or tested in accordance with applicable ASTM standards. For current code evaluation reports, Weyerhaeuser product literature and installation details refer to www.weyerhaeuser.com/woodproducts/document-library.

The product application, input design loads, dimensions and support information have been provided by ForteWEB Software Operator

ForteWEB Software Operator	Job Notes
dong shin D.S. Engineering PC (425) 338-4776 shin_don@hotmail.com	



5/9/2022 6:13:26 AM UTC
 ForteWEB v3.2, Engine: V8.2.0.17, Data: V8.1.0.16

File Name: Strand
 00423 Page 1/1

Handwritten: 20

ROOF:

DL: 25 PSF (INCLUDED 10 PSF SOLAR)
 LL: 20 PSF
 SL: 25 PSF

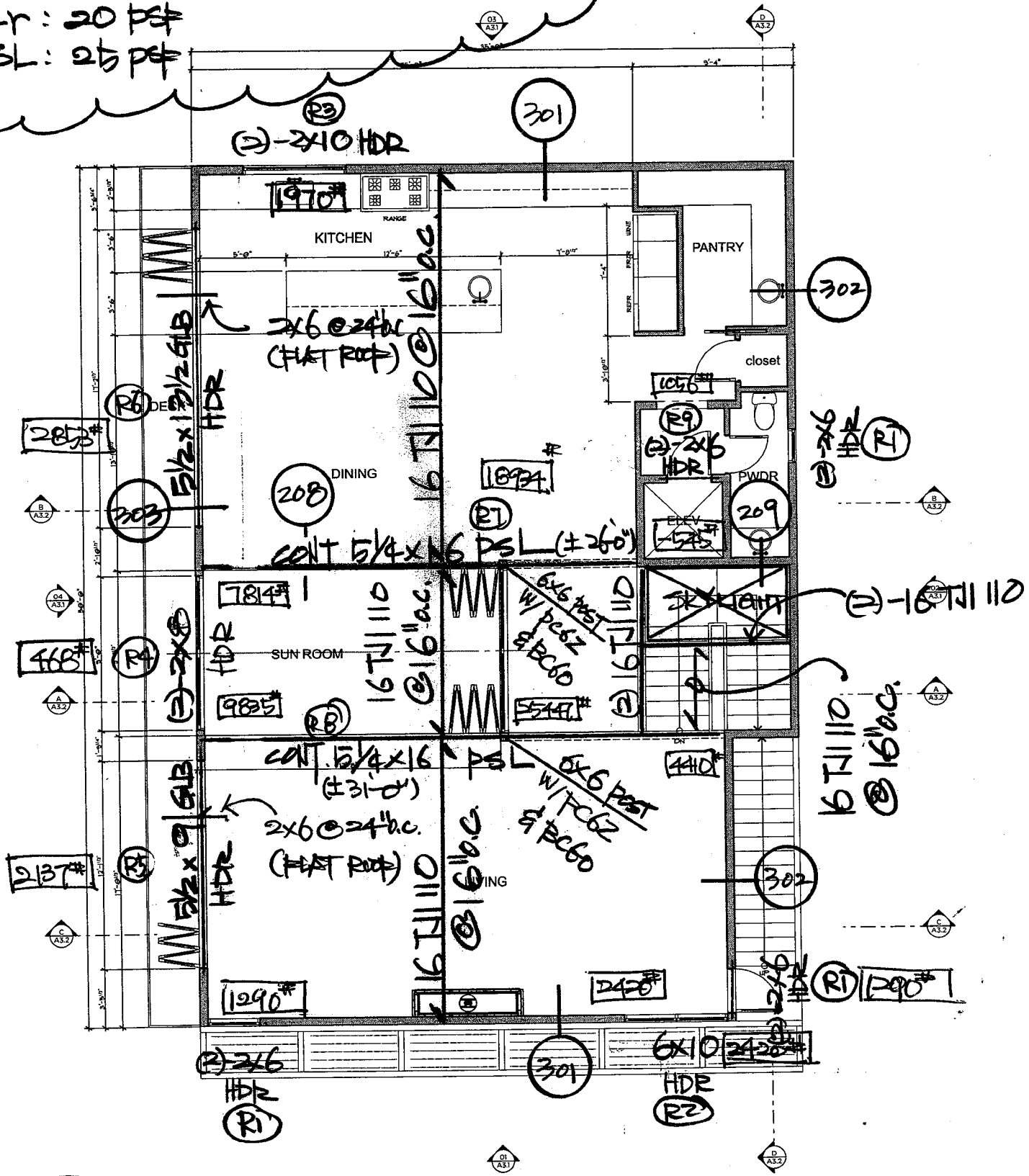

SECOND FLOOR PLAN

SCALE: 1/4" = 1'-0"

DECK
 DL: 20 PSF
 LL: 60 PSF
 SL: 25 PSF

ROOF FRAMING PLAN

1'-6"

$P_{allow} = 3000 \text{ PSF} \times 1.5' \times 3' = 13500 \text{ #}$

$W_{allow} = 3000 \text{ #} \times 1.5' = 4500 \text{ #/1}$

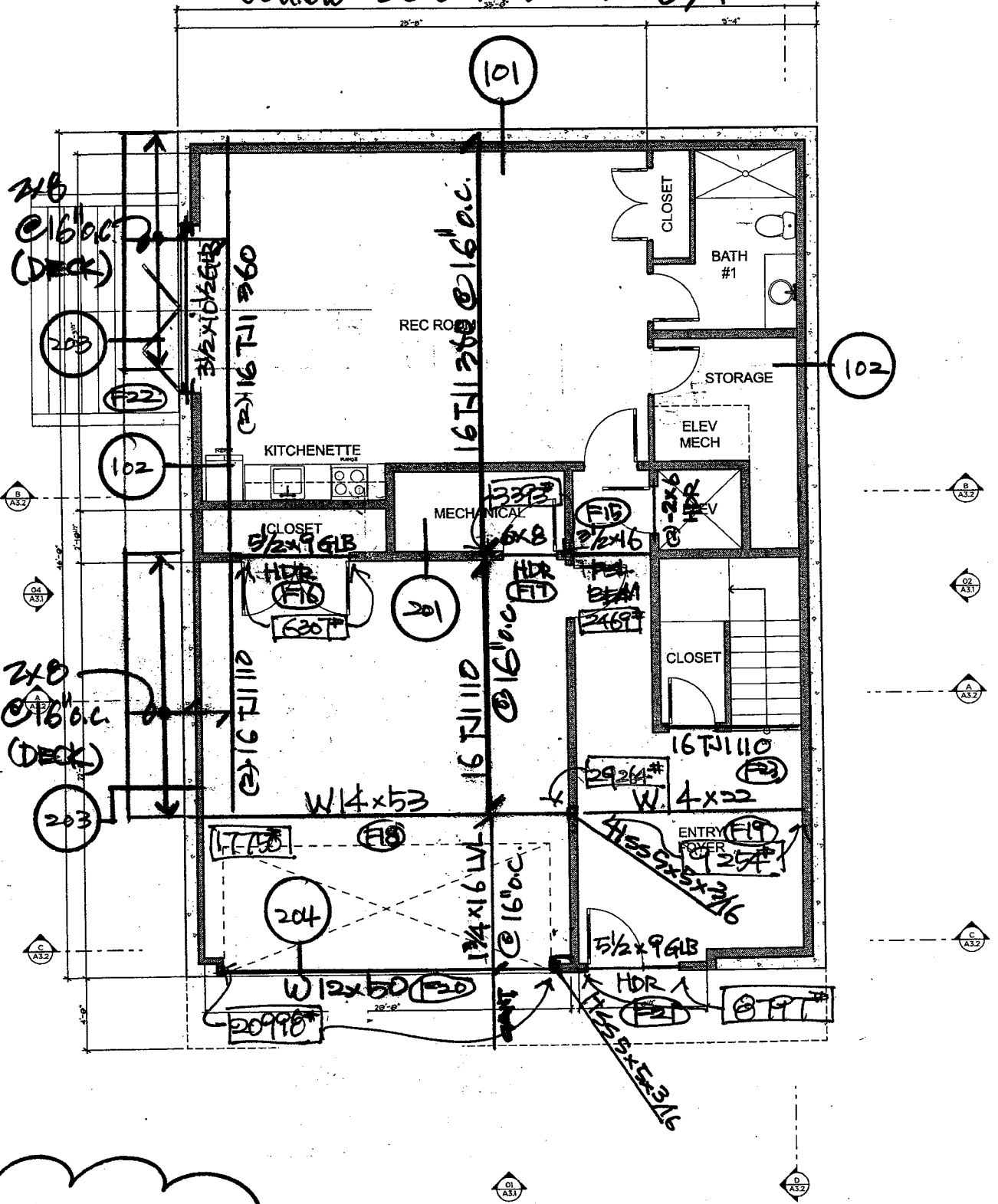

FLOOR
 DL: 12 PSF
 LI: 40 PSF
 (60 PSF @ DECK)

B A S E M E N T P L A N

SCALE: 1/4" = 1'-0"

1ST FLOOR
FRAMING PLAN
 00427
 RT3

(EAST WALL)

RetainPro (c) 1987-2019, Build 11.20.03.31
 License : KW-06061521
 License To : D.S. Engineering

Cantilevered Retaining Wall

Code: IBC 2018, ACI 318-14, TMS 402-16

Criteria

Retained Height = 8.50 ft
 Wall height above soil = 0.50 ft
 Slope Behind Wall = 0.00
 Height of Soil over Toe = 12.00 in
 Water height over heel = 0.0 ft

Soil Data

Allow Soil Bearing = 3,000.0 psf
 Equivalent Fluid Pressure Method
 Active Heel Pressure = 55.0 psf/ft
 Passive Pressure = 300.0 psf/ft
 Soil Density, Heel = 110.00 pcf
 Soil Density, Toe = 110.00 pcf
 Footing||Soil Friction = 0.250
 Soil height to ignore passive pressure = 12.00 in

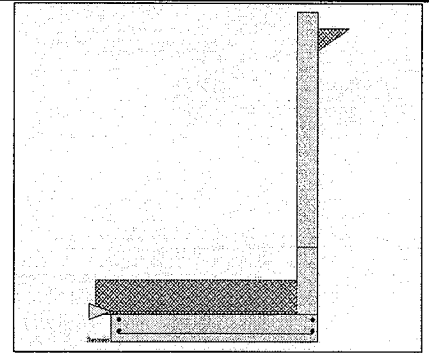

Surcharge Loads

Surcharge Over Heel = 0.0 psf
 Used To Resist Sliding & Overturning
 Surcharge Over Toe = 0.0 psf
 NOT Used for Sliding & Overturning

Lateral Load Applied to Stem

Lateral Load = 14.0 #/ft
 ...Height to Top = 0.50 ft
 ...Height to Bottom = 0.00 ft
 Load Type = Wind (W)
 (Service Level)
 Wind on Exposed Stem = 14.0 psf
 (Service Level)
 Wind acts left-to-right toward retention side.

Adjacent Footing Load

Adjacent Footing Load = 0.0 lbs
 Footing Width = 0.00 ft
 Eccentricity = 0.00 in
 Wall to Ftg CL Dist = 0.00 ft
 Footing Type = Square Footing
 Base Above/Below Soil at Back of Wall = 0.0 ft
 Poisson's Ratio = 0.300

Axial Load Applied to Stem

Axial Dead Load = 180.0 lbs
 Axial Live Load = 73.0 lbs
 Axial Load Eccentricity = 0.0 in

Earth Pressure Seismic Load

Method : Uniform
 Multiplier Used = 1.100
 (Multiplier used on soil density)

Uniform Seismic Force = 10.267
 Total Seismic Force = 95.822

> 93 (= 9H) ← 10.33'

Design Summary

Wall Stability Ratios
 Overturning = 1.50 OK
 Slab Resists All Sliding !
 Total Bearing Load = 2,646 lbs
 ...resultant ecc. = 20.26 in
 Soil Pressure @ Toe = 1,072 psf OK
 Soil Pressure @ Heel = 0 psf OK
 Allowable = 3,000 psf
 Soil Pressure Less Than Allowable
 ACI Factored @ Toe = 1,501 psf
 ACI Factored @ Heel = 0 psf
 Footing Shear @ Toe = 22.2 psi OK
 Footing Shear @ Heel = 1.3 psi OK
 Allowable = 82.2 psi
Sliding Calcs
 Lateral Sliding Force = 2,462.6 lbs

Stem Construction

	2nd	Bottom
Design Height Above Ftg	ft = Stem OK	Stem OK
Wall Material Above "H"	= Concrete	Concrete
Design Method	= LRFD	LRFD
Thickness	= 8.00	8.00
Rebar Size	= # 5	# 5
Rebar Spacing	= 14.00	7.00
Rebar Placed at	= Edge	Edge

Design Data
 fb/FB + fa/Fa = 0.625 0.728

Total Force @ Section
 Service Level lbs =
 Strength Level lbs = 2,032.8 3,465.0

Moment....Actual
 Service Level ft-# =
 Strength Level ft-# = 4,435.0 9,863.6
Moment....Allowable ft-# = 7,086.1 13,547.3

Shear....Actual
 Service Level psi =
 Strength Level psi = 27.4 46.7
Shear....Allowable psi = 82.2 82.2
 Anet (Masonry) in2 =
 Rebar Depth 'd' in = 6.19 6.19

Masonry Data
 f'm psi =
 Fs psi =
 Solid Grouting =
 Modular Ratio 'n' =
 Wall Weight psf = 100.0 100.0
 Short Term Factor =
 Equiv. Solid Thick. =
 Masonry Block Type = Medium Weight
 Masonry Design Method = ASD

Concrete Data
 f'c psi = 3,000.0 3,000.0
 Fy psi = 60,000.0 60,000.0

Vertical component of active lateral soil pressure IS NOT considered in the calculation of soil bearing

Load Factors
 Building Code IBC 2018, ACI
 Dead Load 1.400
 Live Load 1.700
 Earth, H 1.700
 Wind, W 1.300
 Seismic, E 1.000

(EXIST WALL)

RetainPro (c) 1987-2019, Build 11.20.03.31
 License : KW-06061521
 License To : D.S. Engineering

Cantilevered Retaining Wall

Code: IBC 2018, ACI 318-14, TMS 402-16

Concrete Stem Rebar Area Details

2nd Stem	Vertical Reinforcing	Horizontal Reinforcing
As (based on applied moment) :	0.1679 in2/ft	
(4/3) * As :	0.2239 in2/ft	Min Stem T&S Reinf Area 1.344 in2
200bd/fy : 200(12)(6.1875)/60000 :	0.2475 in2/ft	Min Stem T&S Reinf Area per ft of stem Height : 0.192 in2/ft
0.0018bh : 0.0018(12)(8) :	0.1728 in2/ft	Horizontal Reinforcing Options :
	=====	One layer of : Two layers of :
Required Area :	0.2239 in2/ft	#4@ 12.50 in #4@ 25.00 in
Provided Area :	0.2657 in2/ft	#5@ 19.38 in #5@ 38.75 in
Maximum Area :	1.0059 in2/ft	#6@ 27.50 in #6@ 55.00 in

Bottom Stem	Vertical Reinforcing	Horizontal Reinforcing
As (based on applied moment) :	0.3735 in2/ft	
(4/3) * As :	0.498 in2/ft	Min Stem T&S Reinf Area 0.384 in2
200bd/fy : 200(12)(6.1875)/60000 :	0.2475 in2/ft	Min Stem T&S Reinf Area per ft of stem Height : 0.192 in2/ft
0.0018bh : 0.0018(12)(8) :	0.1728 in2/ft	Horizontal Reinforcing Options :
	=====	One layer of : Two layers of :
Required Area :	0.3735 in2/ft	#4@ 12.50 in #4@ 25.00 in
Provided Area :	0.5314 in2/ft	#5@ 19.38 in #5@ 38.75 in
Maximum Area :	1.0059 in2/ft	#6@ 27.50 in #6@ 55.00 in

Footing Data

Toe Width	=	6.00 ft
Heel Width	=	0.67
Total Footing Width	=	6.67
Footing Thickness	=	10.00 in
Key Width	=	0.00 in
Key Depth	=	0.00 in
Key Distance from Toe	=	0.00 ft
f_c	=	3,000 psi
F_y	=	60,000 psi
Footing Concrete Density	=	150.00 pcf
Min. As %	=	0.0018
Cover @ Top	=	2.00 in
	@ Btm =	3.00 in

Footing Design Results

	<u>Toe</u>	<u>Heel</u>
Factored Pressure	= 1,501	0 psf
Mu' : Upward	= 193,607	0 ft-#
Mu' : Downward	= 71,064	0 ft-#
Mu: Design	= 10,212	0 ft-#
Actual 1-Way Shear	= 22.17	1.29 psi
Allow 1-Way Shear	= 82.16	43.82 psi
Toe Reinforcing	= # 5 @ 7.00 in	
Heel Reinforcing	= None Spec'd	
Key Reinforcing	= # 4 @ 18.00 in	
Footing Torsion, Tu	=	0.00 ft-lbs
Footing Allow. Torsion, phi Tu	=	0.00 ft-lbs

If torsion exceeds allowable, provide supplemental design for footing torsion.

Other Acceptable Sizes & Spacings

Toe: #4@ 6.53 in, #5@ 10.13 in, #6@ 14.38 in, #7@ 19.61 in, #8@ 25.82 in, #9@ 32
 Heel: $\phi M_n = \phi'5' \lambda \sqrt{f_c} S_m$
 Key: No key defined

Min footing T&S reinf Area	1.44 in2
Min footing T&S reinf Area per foot	0.22 in2 /ft
If one layer of horizontal bars:	If two layers of horizontal bars:
#4@ 11.11 in	#4@ 22.22 in
#5@ 17.22 in	#5@ 34.44 in
#6@ 24.44 in	#6@ 48.89 in

(EAST WALL)

RetainPro (c) 1987-2019, Build 11.20.03.31
 License : KW-06061521
 License To : D.S. Engineering

Cantilevered Retaining Wall

Code: IBC 2018,ACI 318-14,TMS 402-16

Summary of Overturning & Resisting Forces & Moments

ItemOVERTURNING.....		RESISTING.....		
	Force lbs	Distance ft	Moment ft-#	Force lbs	Distance ft	Moment ft-#
HL Act Pres (ab water tbl)	2,395.6	3.11	7,452.8	Soil Over HL (ab. water tbl)		
HL Act Pres (be water tbl)				Soil Over HL (bel. water tbl)		
Hydrostatic Force				Watre Table		
Buoyant Force =				Sloped Soil Over Heel =		
Surcharge over Heel =				Surcharge Over Heel =		
Surcharge Over Toe =				Adjacent Footing Load =		
Adjacent Footing Load =				Axial Dead Load on Stem =	253.0	6.33 1,140.0
Added Lateral Load =	7.0	1.08	7.6	* Axial Live Load on Stem =	73.0	6.33 462.3
Load @ Stem Above Soil =	-7.0	9.58	-67.1	Soil Over Toe =	660.0	3.00 1,980.0
Seismic Earth Load =	67.1	4.67	313.0	Surcharge Over Toe =		
				Stem Weight(s) =	900.0	6.33 5,700.0
				Earth @ Stem Transitions =		
Total	= 2,462.6	O.T.M. =	7,706.4	Footing Weight =	833.3	3.33 2,777.8
				Key Weight =		
				Vert. Component =		
Resisting/Overturning Ratio		= 1.50		Total =	2,573.3 lbs	R.M.= 11,597.8
Vertical Loads used for Soil Pressure =		2,646.3 lbs				

* Axial live load NOT included in total displayed, or used for overturning resistance, but is included for soil pressure calculation.

If seismic is included, the OTM and sliding ratios may be 1.1 per section 1807.2.3 of IBC.

Vertical component of active lateral soil pressure IS NOT considered in the calculation of Sliding Resistance.

Vertical component of active lateral soil pressure IS NOT considered in the calculation of Overturning Resistance.

Tilt

Horizontal Deflection at Top of Wall due to settlement of soil

(Deflection due to wall bending not considered)

Soil Spring Reaction Modulus 250.0 pci

Horizontal Defl @ Top of Wall (approximate only) 0.040 in

The above calculation is not valid if the heel soil bearing pressure exceeds that of the toe, because the wall would then tend to rotate into the retained soil.

(WEST WALL)

RetainPro (c) 1987-2019, Build 11.20.03.31
 License : KW-06061521
 License To : D.S. Engineering

Cantilevered Retaining Wall

Code: IBC 2018, ACI 318-14, TMS 402-16

Criteria

Retained Height = 5.50 ft
 Wall height above soil = 4.00 ft
 Slope Behind Wall = 0.00
 Height of Soil over Toe = 12.00 in
 Water height over heel = 0.0 ft

Soil Data

Allow Soil Bearing = 3,000.0 psf
 Equivalent Fluid Pressure Method
 Active Heel Pressure = 35.0 psf/ft
 Passive Pressure = 300.0 psf/ft
 Soil Density, Heel = 110.00 pcf
 Soil Density, Toe = 110.00 pcf
 Footing||Soil Friction = 0.500
 Soil height to ignore for passive pressure = 12.00 in

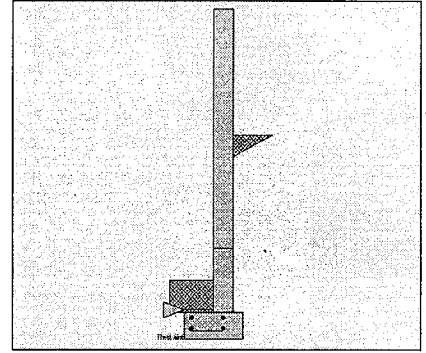

Surcharge Loads

Surcharge Over Heel = 0.0 psf
 Used To Resist Sliding & Overturning
 Surcharge Over Toe = 0.0 psf
 NOT Used for Sliding & Overturning

Lateral Load Applied to Stem

Lateral Load = 0.0 #/ft
 ...Height to Top = 0.00 ft
 ...Height to Bottom = 0.00 ft
 Load Type = Wind (W)
 (Service Level)
 Wind on Exposed Stem = 14.0 psf
 (Service Level)
 Wind acts left-to-right toward retention side.

Adjacent Footing Load

Adjacent Footing Load = 0.0 lbs
 Footing Width = 0.00 ft
 Eccentricity = 0.00 in
 Wall to Ftg CL Dist = 0.00 ft
 Footing Type = Square Footing
 Base Above/Below Soil at Back of Wall = 0.0 ft
 Poisson's Ratio = 0.300

Axial Load Applied to Stem

Axial Dead Load = 180.0 lbs
 Axial Live Load = 73.0 lbs
 Axial Load Eccentricity = 0.0 in

Earth Pressure Seismic Load

Method : Uniform
 Multiplier Used = 2.500
 (Multiplier used on soil density)

Uniform Seismic Force = 15.833
 Total Seismic Force = 100.278

10.33'
 > 93 (=9H)

Design Summary

Wall Stability Ratios
 Overturning = 1.76 OK
 Slab Resists All Sliding !

Total Bearing Load = 1,765 lbs
 ...resultant ecc. = 4.92 in

Soil Pressure @ Toe = 1,994 psf OK
 Soil Pressure @ Heel = 0 psf OK
 Allowable = 3,000 psf
 Soil Pressure Less Than Allowable
 ACI Factored @ Toe = 2,791 psf
 ACI Factored @ Heel = 0 psf
 Footing Shear @ Toe = 12.2 psi OK
 Footing Shear @ Heel = 3.5 psi OK
 Allowable = 82.2 psi

Sliding Calcs
 Lateral Sliding Force = 716.1 lbs

Stem Construction

	2nd	Bottom
Design Height Above Ftg	ft = Stem OK 2.00	Stem OK 0.00
Wall Material Above "Ht"	= Concrete	Concrete
Design Method	= LRFD	LRFD
Thickness	= 8.00	8.00
Rebar Size	= # 5	# 5
Rebar Spacing	= 16.00	16.00
Rebar Placed at	= Center	Center

Design Data
 fb/FB + fa/Fa = 0.030 0.340

Total Force @ Section
 Service Level lbs =
 Strength Level lbs = 347.1 914.2

Moment....Actual
 Service Level ft-# =
 Strength Level ft-# = 121.8 1,343.4
Moment....Allowable ft-# = 3,945.8 3,945.8

Shear....Actual
 Service Level psi =
 Strength Level psi = 7.2 19.0
Shear....Allowable psi = 82.2 82.2
 Anet (Masonry) in2 =
 Rebar Depth 'd' in = 4.00 4.00

Masonry Data
 fm psi =
 Fs psi =
 Solid Grouting =
 Modular Ratio 'n' =
 Wall Weight psf = 100.0 100.0
 Short Term Factor =
 Equiv. Solid Thick. =
 Masonry Block Type = Medium Weight
 Masonry Design Method = ASD

Concrete Data
 fc psi = 3,000.0 3,000.0
 Fy psi = 60,000.0 60,000.0

Vertical component of active lateral soil pressure IS NOT considered in the calculation of soil bearing

Load Factors
 Building Code IBC 2018, ACI
 Dead Load 1.400
 Live Load 1.700
 Earth, H 1.700
 Wind, W 1.300
 Seismic, E 1.000

(WEST WALK)

Cantilevered Retaining Wall

RetainPro (c) 1987-2019, Build 11.20.03.31
License : KW-06061521
License To : D.S. Engineering

Code: IBC 2018, ACI 318-14, TMS 402-16

Concrete Stem Rebar Area Details

2nd Stem	Vertical Reinforcing	Horizontal Reinforcing
As (based on applied moment) :	0.0073 in ² /ft	
(4/3) * As :	0.0098 in ² /ft	Min Stem T&S Reinf Area 1.440 in ²
200bd/fy : 200(12)(4)/60000 :	0.16 in ² /ft	Min Stem T&S Reinf Area per ft of stem Height : 0.192 in ² /ft
0.0018bh : 0.0018(12)(8) :	0.1728 in ² /ft	Horizontal Reinforcing Options :
	=====	One layer of : Two layers of :
Required Area :	0.1728 in ² /ft	#4@ 12.50 in #4@ 25.00 in
Provided Area :	0.2325 in ² /ft	#5@ 19.38 in #5@ 38.75 in
Maximum Area :	0.6503 in ² /ft	#6@ 27.50 in #6@ 55.00 in

Bottom Stem	Vertical Reinforcing	Horizontal Reinforcing
As (based on applied moment) :	0.0811 in ² /ft	
(4/3) * As :	0.1081 in ² /ft	Min Stem T&S Reinf Area 0.384 in ²
200bd/fy : 200(12)(4)/60000 :	0.16 in ² /ft	Min Stem T&S Reinf Area per ft of stem Height : 0.192 in ² /ft
0.0018bh : 0.0018(12)(8) :	0.1728 in ² /ft	Horizontal Reinforcing Options :
	=====	One layer of : Two layers of :
Required Area :	0.1728 in ² /ft	#4@ 12.50 in #4@ 25.00 in
Provided Area :	0.2325 in ² /ft	#5@ 19.38 in #5@ 38.75 in
Maximum Area :	0.6503 in ² /ft	#6@ 27.50 in #6@ 55.00 in

Footing Data

Toe Width	=	1.00 ft
Heel Width	=	1.00
Total Footing Width	=	2.00
Footing Thickness	=	10.00 in
Key Width	=	0.00 in
Key Depth	=	0.00 in
Key Distance from Toe	=	0.00 ft
f _c =	3,000 psi	F _y = 60,000 psi
Footing Concrete Density	=	150.00 pcf
Min. As %	=	0.0018
Cover @ Top	2.00	@ Btm = 3.00 in

Footing Design Results

	Toe	Heel
Factored Pressure	= 2,791	0 psf
Mu' : Upward	= 13,594	0 ft-#
Mu' : Downward	= 1,974	57 ft-#
Mu: Design	= 968	57 ft-#
Actual 1-Way Shear	= 12.15	3.55 psi
Allow 1-Way Shear	= 82.16	43.82 psi
Toe Reinforcing	= # 5 @ 16.00 in	
Heel Reinforcing	= None Spec'd	
Key Reinforcing	= # 4 @ 18.00 in	
Footing Torsion, Tu	=	0.00 ft-lbs
Footing Allow. Torsion, phi Tu	=	0.00 ft-lbs

If torsion exceeds allowable, provide supplemental design for footing torsion.

Other Acceptable Sizes & Spacings

Toe: #4@ 11.11 in, #5@ 17.22 in, #6@ 24.44 in, #7@ 33.33 in, #8@ 43.88 in, #9@ 5
Heel: phiMn = phi⁵lambda*sqrt(fc)'Sm
Key: No key defined

Min footing T&S reinf Area	0.43 in ²
Min footing T&S reinf Area per foot	0.22 in ² /ft
If one layer of horizontal bars:	If two layers of horizontal bars:
#4@ 11.11 in	#4@ 22.22 in
#5@ 17.22 in	#5@ 34.44 in
#6@ 24.44 in	#6@ 48.89 in

(WEST WALL)

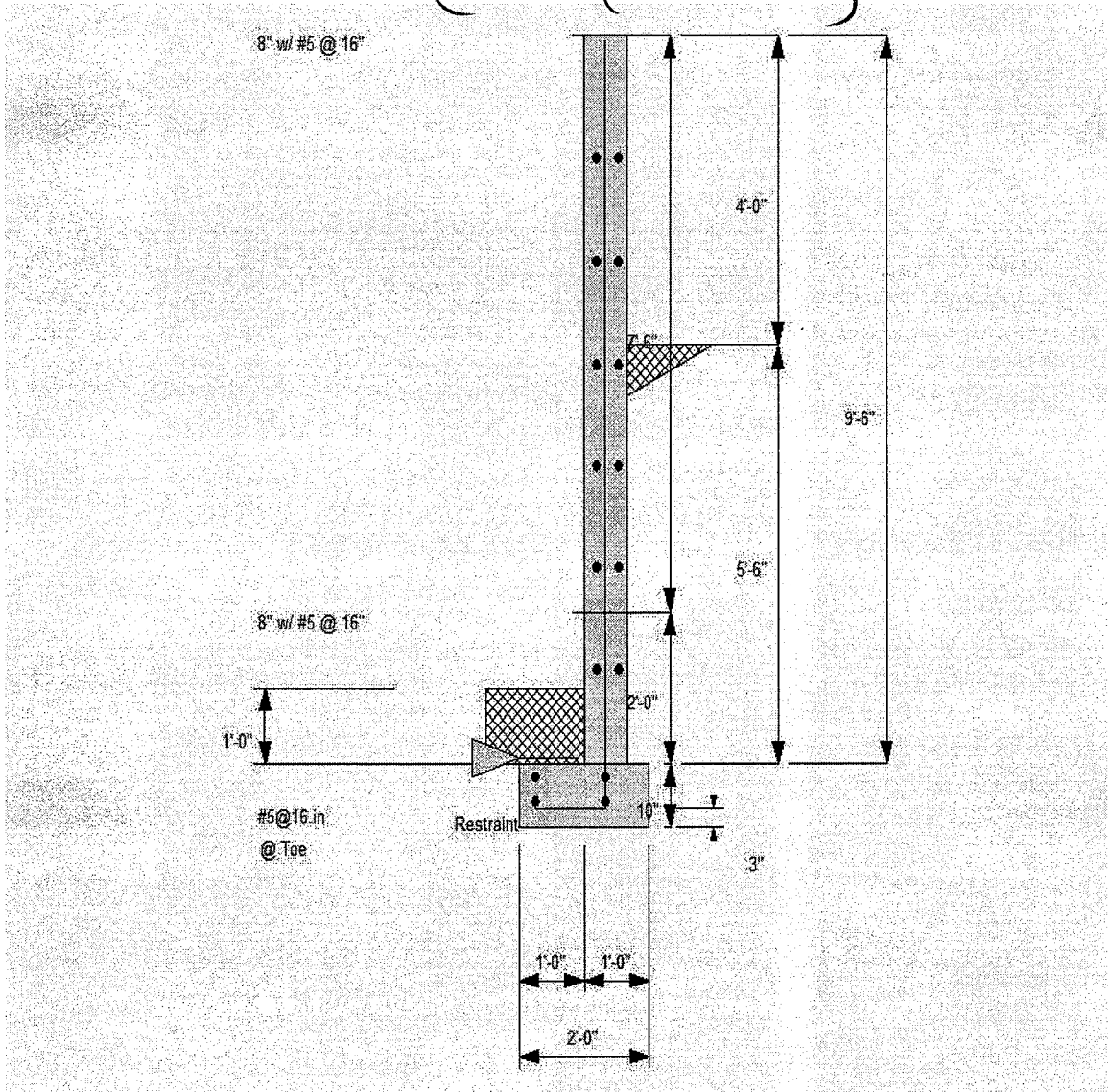

(NORTH WALL)

RetainPro (c) 1987-2019, Build 11.20.03.31
 License : KW-06061521
 License To : D.S. Engineering

Cantilevered Retaining Wall

Code: IBC 2018, ACI 318-14, TMS 402-16

Criteria

Retained Height = 6.50 ft
 Wall height above soil = 3.00 ft
 Slope Behind Wall = 0.00
 Height of Soil over Toe = 12.00 in
 Water height over heel = 0.0 ft

Soil Data

Allow Soil Bearing = 3,000.0 psf
 Equivalent Fluid Pressure Method
 Active Heel Pressure = 35.0 psf/ft
 Passive Pressure = 300.0 psf/ft
 Soil Density, Heel = 110.00 pcf
 Soil Density, Toe = 110.00 pcf
 Equivalent Soil Friction = 0.500
 Soil height to ignore for passive pressure = 12.00 in

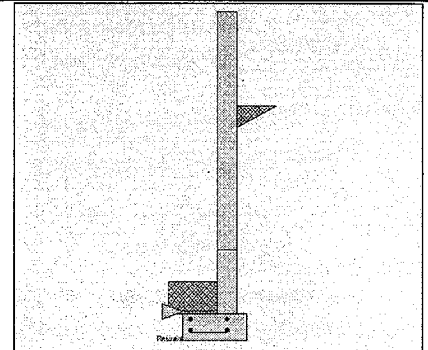

Surcharge Loads

Surcharge Over Heel = 0.0 psf
 Used To Resist Sliding & Overturning
 Surcharge Over Toe = 0.0 psf
 NOT Used for Sliding & Overturning

Lateral Load Applied to Stem

Lateral Load = 0.0 #/ft
 ...Height to Top = 0.00 ft
 ...Height to Bottom = 0.00 ft
 Load Type = Wind (W)
 (Service Level)
 Wind on Exposed Stem = 14.0 psf
 (Service Level)
 Wind acts left-to-right toward retention side.

Adjacent Footing Load

Adjacent Footing Load = 0.0 lbs
 Footing Width = 0.00 ft
 Eccentricity = 0.00 in
 Wall to Ftg CL Dist = 0.00 ft
 Footing Type = Square Footing
 Base Above/Below Soil = 0.0 ft
 at Back of Wall
 Poisson's Ratio = 0.300

Axial Load Applied to Stem

Axial Dead Load = 690.0 lbs
 Axial Live Load = 1,150.0 lbs
 Axial Load Eccentricity = 0.0 in

Earth Pressure Seismic Load

Method : Uniform
 Multiplier Used = 1.900
 (Multiplier used on soil density)

Uniform Seismic Force = 13.933
 Total Seismic Force = 102.178

Handwritten notes: 10.33 , $> 92 (=911)$

Design Summary

Wall Stability Ratios
 Overturning = 1.51 OK
 Slab Resists All Sliding !

Total Bearing Load = 3,428 lbs
 ...resultant ecc. = 3.05 in

Soil Pressure @ Toe = 2,688 psf OK
 Soil Pressure @ Heel = 471 psf OK
 Allowable = 3,000 psf
 Soil Pressure Less Than Allowable
 ACI Factored @ Toe = 3,764 psf
 ACI Factored @ Heel = 660 psf
 Footing Shear @ Toe = 23.8 psi OK
 Footing Shear @ Heel = 4.1 psi OK
 Allowable = 82.2 psi

Sliding Calcs

Lateral Sliding Force = 970.6 lbs

Stem Construction

	2nd	Bottom
Design Height Above Ftg	ft = Stem OK 2.00	Stem OK 0.00
Wall Material Above "Ht"	= Concrete	Concrete
Design Method	= LRFD	LRFD
Thickness	= 8.00	8.00
Rebar Size	= # 5	# 5
Rebar Spacing	= 16.00	16.00
Rebar Placed at	= Center	Center

Design Data

fb/FB + fa/Fa = 0.181 0.654

Total Force @ Section

Service Level lbs =
 Strength Level lbs = 610.5 1,292.9

Moment....Actual

Service Level ft-# =
 Strength Level ft-# = 717.1 2,580.9

Moment....Allowable

ft-# = 3,945.8 3,945.8

Shear....Actual

Service Level psi =
 Strength Level psi = 12.7 26.9

Shear....Allowable

psi = 82.2 82.2

Anet (Masonry)

in2 =

Rebar Depth 'd'

in = 4.00 4.00

Masonry Data

f_m psi =
 F_s psi =
 Solid Grouting =
 Modular Ratio 'n' =
 Wall Weight psf = 100.0 100.0

Short Term Factor

=
 Equiv. Solid Thick. =
 Masonry Block Type = Medium Weight
 Masonry Design Method = ASD

Concrete Data

f_c psi = 3,000.0 3,000.0
 F_y psi = 60,000.0 60,000.0

Vertical component of active lateral soil pressure IS NOT considered in the calculation of soil bearing

Load Factors

Building Code IBC 2018, ACI
 Dead Load 1.400
 Live Load 1.700
 Earth, H 1.700
 Wind, W 1.300
 Seismic, E 1.000

(NORTH WALL)

RetainPro (c) 1987-2019, Build 11.20.03.31
 License : KW-06061521
 License To : D.S. Engineering

Cantilevered Retaining Wall

Code: IBC 2018, ACI 318-14, TMS 402-16

Concrete Stem Rebar Area Details

2nd Stem	Vertical Reinforcing	Horizontal Reinforcing	
As (based on applied moment) :	0.0433 in2/ft		
(4/3) * As :	0.0577 in2/ft	Min Stem T&S Reinf Area 1.440 in2	
200bd/fy : 200(12)(4)/60000 :	0.16 in2/ft	Min Stem T&S Reinf Area per ft of stem Height : 0.192 in2/ft	
0.0018bh : 0.0018(12)(8) :	0.1728 in2/ft	Horizontal Reinforcing Options :	
	=====	One layer of :	Two layers of :
Required Area :	0.1728 in2/ft	#4@ 12.50 in	#4@ 25.00 in
Provided Area :	0.2325 in2/ft	#5@ 19.38 in	#5@ 38.75 in
Maximum Area :	0.6503 in2/ft	#6@ 27.50 in	#6@ 55.00 in

Bottom Stem	Vertical Reinforcing	Horizontal Reinforcing	
As (based on applied moment) :	0.1558 in2/ft		
(4/3) * As :	0.2077 in2/ft	Min Stem T&S Reinf Area 0.384 in2	
200bd/fy : 200(12)(4)/60000 :	0.16 in2/ft	Min Stem T&S Reinf Area per ft of stem Height : 0.192 in2/ft	
0.0018bh : 0.0018(12)(8) :	0.1728 in2/ft	Horizontal Reinforcing Options :	
	=====	One layer of :	Two layers of :
Required Area :	0.16 in2/ft	#4@ 12.50 in	#4@ 25.00 in
Provided Area :	0.2325 in2/ft	#5@ 19.38 in	#5@ 38.75 in
Maximum Area :	0.6503 in2/ft	#6@ 27.50 in	#6@ 55.00 in

Footing Data

Toe Width	=	1.17 ft
Heel Width	=	1.00
Total Footing Width	=	2.17
Footing Thickness	=	10.00 in
Key Width	=	0.00 in
Key Depth	=	0.00 in
Key Distance from Toe	=	0.00 ft
fc =	3,000 psi	Fy = 60,000 psi
Footing Concrete Density	=	150.00 pcf
Min. As %	=	0.0018
Cover @ Top	2.00	@ Btm = 3.00 in

Footing Design Results

	<u>Toe</u>	<u>Heel</u>
Factored Pressure	= 3,764	660 psf
Mu' : Upward	= 26,332	0 ft-#
Mu' : Downward	= 2,702	65 ft-#
Mu: Design	= 1,969	65 ft-#
Actual 1-Way Shear	= 23.78	4.08 psi
Allow 1-Way Shear	= 82.16	43.82 psi
Toe Reinforcing	= # 5 @ 12.00 in	
Heel Reinforcing	= None Spec'd	
Key Reinforcing	= # 4 @ 18.00 in	
Footing Torsion, Tu	=	0.00 ft-lbs
Footing Allow. Torsion, phi Tu	=	0.00 ft-lbs

If torsion exceeds allowable, provide supplemental design for footing torsion.

Other Acceptable Sizes & Spacings

Toe: #4@ 11.11 in, #5@ 17.22 in, #6@ 24.44 in, #7@ 33.33 in, #8@ 43.88 in, #9@ 5
 Heel: phiMn = phi^5 lambda da sqrt(fc) Sm
 Key: No key defined

Min footing T&S reinf Area	0.47 in2
Min footing T&S reinf Area per foot	0.22 in2 /ft
If one layer of horizontal bars:	If two layers of horizontal bars:
#4@ 11.11 in	#4@ 22.22 in
#5@ 17.22 in	#5@ 34.44 in
#6@ 24.44 in	#6@ 48.89 in

(NORTH WALK)
Cantilevered Retaining Wall

RetainPro (c) 1987-2019, Build 11.20.03.31
 License : KW-06061521
 License To : D.S. Engineering

Code: IBC 2018,ACI 318-14,TMS 402-16

Summary of Overturning & Resisting Forces & Moments

ItemOVERTURNING.....		RESISTING.....			
	Force lbs	Distance ft	Moment ft-#	Force lbs	Distance ft	Moment ft-#	
HL Act Pres (ab water tbl)	941.1	2.44	2,300.5	Soil Over HL (ab. water tbl)	238.3	2.00	477.5
HL Act Pres (be water tbl)				Soil Over HL (bel. water tbl)		2.00	477.5
Hydrostatic Force				Watre Table			
Buoyant Force =				Sloped Soil Over Heel =			
Surcharge over Heel =				Surcharge Over Heel =			
Surcharge Over Toe =				Adjacent Footing Load =			
Adjacent Footing Load =				Axial Dead Load on Stem =	1,840.0	1.50	1,037.3
Added Lateral Load =				* Axial Live Load on Stem =	1,150.0	1.50	1,728.8
Load @ Stem Above Soil =	-42.0	8.83	-371.0	Soil Over Toe =	128.7	0.59	75.3
Seismic Earth Load =	71.5	3.67	262.3	Surcharge Over Toe =			
				Stem Weight(s) =	950.0	1.50	1,428.2
				Earth @ Stem Transitions =			
Total =	970.6	O.T.M.	= 2,191.8	Footing Weight =	271.3	1.09	294.3
				Key Weight =			
				Vert. Component =			
Resisting/Overturning Ratio =			1.51	Total =	2,278.3 lbs	R.M.=	3,312.5
Vertical Loads used for Soil Pressure =		3,428.3 lbs					

* Axial live load NOT included in total displayed, or used for overturning resistance, but is included for soil pressure calculation.

If seismic is included, the OTM and sliding ratios may be 1.1 per section 1807.2.3 of IBC.

Vertical component of active lateral soil pressure IS NOT considered in the calculation of Sliding Resistance.

Vertical component of active lateral soil pressure IS NOT considered in the calculation of Overturning Resistance.

Tilt

Horizontal Deflection at Top of Wall due to settlement of soil

(Deflection due to wall bending not considered)

Soil Spring Reaction Modulus 250.0 pci

Horizontal Defl @ Top of Wall (approximate only) 0.327 in

The above calculation is not valid if the heel soil bearing pressure exceeds that of the toe, because the wall would then tend to rotate into the retained soil.

(NORTH SIDE)

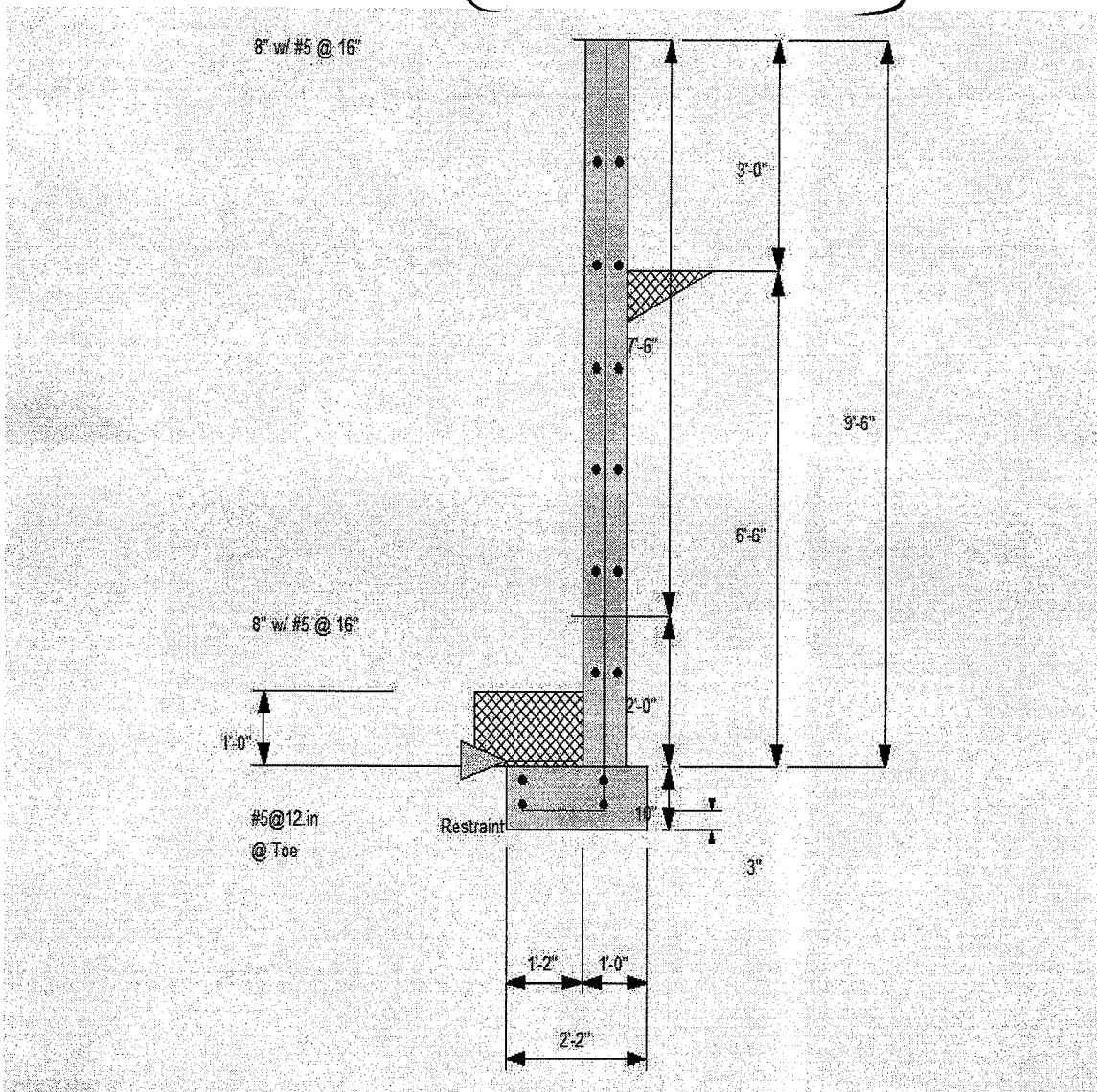

(NORTH WALL)

RetainPro (c) 1987-2019, Build 11.20.03.31
 License : KW-06061521
 License To : D.S. Engineering

Cantilevered Retaining Wall

Code: IBC 2018, ACI 318-14, TMS 402-16

Criteria

Retained Height = 8.00 ft
 Wall height above soil = 0.50 ft
 Slope Behind Wall = 0.00
 Height of Soil over Toe = 12.00 in
 Water height over heel = 0.0 ft

Soil Data

Allow Soil Bearing = 3,000.0 psf
 Equivalent Fluid Pressure Method
 Active Heel Pressure = 35.0 psf/ft
 Passive Pressure = 300.0 psf/ft
 Soil Density, Heel = 110.00 pcf
 Soil Density, Toe = 110.00 pcf
 Footing||Soil Friction = 0.500
 Soil height to ignore passive pressure = 12.00 in

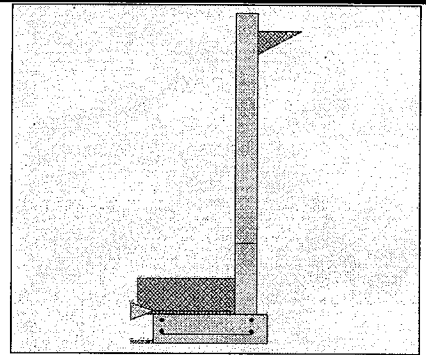

Surcharge Loads

Surcharge Over Heel = 0.0 psf
 Used To Resist Sliding & Overturning
 Surcharge Over Toe = 0.0 psf
 NOT Used for Sliding & Overturning

Lateral Load Applied to Stem

Lateral Load = 0.0 #/ft
 ...Height to Top = 0.00 ft
 ...Height to Bottom = 0.00 ft
 Load Type = Wind (W)
 (Service Level)
 Wind on Exposed Stem = 14.0 psf
 (Service Level)
 Wind acts left-to-right toward retention side.

Adjacent Footing Load

Adjacent Footing Load = 0.0 lbs
 Footing Width = 0.00 ft
 Eccentricity = 0.00 in
 Wall to Ftg CL Dist = 0.00 ft
 Footing Type = Square Footing
 Base Above/Below Soil = 0.0 ft
 at Back of Wall
 Poisson's Ratio = 0.300

Axial Load Applied to Stem

Axial Dead Load = 690.0 lbs
 Axial Live Load = 1,150.0 lbs
 Axial Load Eccentricity = 0.0 in

Earth Pressure Seismic Load

Method : Uniform
 Multiplier Used = 1.330
 (Multiplier used on soil density)

Uniform Seismic Force = 11.748
 Total Seismic Force = 103.777

> 93 (=9H) ← 10.33'

Design Summary

Wall Stability Ratios
 Overturning = 1.51 OK
 Slab Resists All Sliding !
 Total Bearing Load = 3,696 lbs
 ...resultant ecc. = 3.37 in
 Soil Pressure @ Toe = 1,564 psf OK
 Soil Pressure @ Heel = 548 psf OK
 Allowable = 3,000 psf
 Soil Pressure Less Than Allowable
 ACI Factored @ Toe = 2,189 psf
 ACI Factored @ Heel = 767 psf
 Footing Shear @ Toe = 35.9 psi OK
 Footing Shear @ Heel = 4.9 psi OK
 Allowable = 82.2 psi
Sliding Calcs
 Lateral Sliding Force = 1,431.1 lbs

Stem Construction

	2nd	Bottom
Design Height Above Ftg	ft = 2.00	ft = 0.00
Wall Material Above "H"	Concrete	Concrete
Design Method	LRFD	LRFD
Thickness	8.00	8.00
Rebar Size	# 5	# 5
Rebar Spacing	18.00	12.00
Rebar Placed at	Edge	Edge
Design Data		
fb/FB + fa/Fa	0.412	0.655
Total Force @ Section		
Service Level	lbs =	
Strength Level	lbs = 1,132.4	1,988.9
Moment.....Actual		
Service Level	ft-# =	
Strength Level	ft-# = 2,296.6	5,378.2
Moment.....Allowable	ft-# = 5,565.4	8,206.3
Shear.....Actual		
Service Level	psi =	
Strength Level	psi = 15.3	26.8
Shear.....Allowable	psi = 82.2	82.2
Anet (Masonry)	in2 =	
Rebar Depth 'd'	in = 6.19	6.19

Masonry Data

fm psi =
 Fs psi =
 Solid Grouting =
 Modular Ratio 'n' =
 Wall Weight psf = 100.0 100.0
 Short Term Factor =
 Equiv. Solid Thick. =
 Masonry Block Type = Medium Weight
 Masonry Design Method = ASD

Concrete Data

fc psi = 3,000.0 3,000.0
 Fy psi = 60,000.0 60,000.0

Vertical component of active lateral soil pressure IS NOT considered in the calculation of soil bearing

Load Factors

Building Code IBC 2018, ACI
 Dead Load 1.400
 Live Load 1.700
 Earth, H 1.700
 Wind, W 1.300
 Seismic, E 1.000

(NORTH WALL)

RetainPro (c) 1987-2019, Build 11.20.03.31
 License : KW-06061521
 License To : D.S. Engineering

Cantilevered Retaining Wall

Code: IBC 2018, ACI 318-14, TMS 402-16

Concrete Stem Rebar Area Details

2nd Stem	Vertical Reinforcing	Horizontal Reinforcing	
As (based on applied moment) :	0.087 in ² /ft		
(4/3) * As :	0.1159 in ² /ft	Min Stem T&S Reinf Area 1.248 in ²	
200bd/fy : 200(12)(6.1875)/60000 :	0.2475 in ² /ft	Min Stem T&S Reinf Area per ft of stem Height : 0.192 in ² /ft	
0.0018bh : 0.0018(12)(8) :	0.1728 in ² /ft	Horizontal Reinforcing Options :	
	=====	One layer of :	Two layers of :
Required Area :	0.1728 in ² /ft	#4@ 12.50 in	#4@ 25.00 in
Provided Area :	0.2067 in ² /ft	#5@ 19.38 in	#5@ 38.75 in
Maximum Area :	1.0059 in ² /ft	#6@ 27.50 in	#6@ 55.00 in

Bottom Stem	Vertical Reinforcing	Horizontal Reinforcing	
As (based on applied moment) :	0.2036 in ² /ft		
(4/3) * As :	0.2715 in ² /ft	Min Stem T&S Reinf Area 0.384 in ²	
200bd/fy : 200(12)(6.1875)/60000 :	0.2475 in ² /ft	Min Stem T&S Reinf Area per ft of stem Height : 0.192 in ² /ft	
0.0018bh : 0.0018(12)(8) :	0.1728 in ² /ft	Horizontal Reinforcing Options :	
	=====	One layer of :	Two layers of :
Required Area :	0.2475 in ² /ft	#4@ 12.50 in	#4@ 25.00 in
Provided Area :	0.31 in ² /ft	#5@ 19.38 in	#5@ 38.75 in
Maximum Area :	1.0059 in ² /ft	#6@ 27.50 in	#6@ 55.00 in

Footing Data

Toe Width	=	2.50 ft
Heel Width	=	1.00
Total Footing Width	=	3.50
Footing Thickness	=	10.00 in
Key Width	=	0.00 in
Key Depth	=	0.00 in
Key Distance from Toe	=	0.00 ft
f _c =	3,000 psi	F _y = 60,000 psi
Footing Concrete Density	=	150.00 pcf
Min. As %	=	0.0018
Cover @ Top	2.00	@ Btm = 3.00 in

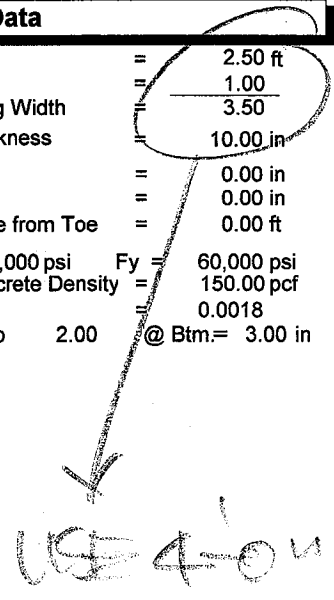

Footing Design Results

	<u>Toe</u>	<u>Heel</u>
Factored Pressure	= 2,189	767 psf
Mu' : Upward	= 69,402	0 ft-#
Mu' : Downward	= 12,338	78 ft-#
Mu: Design	= 4,755	78 ft-#
Actual 1-Way Shear	= 35.89	4.89 psi
Allow 1-Way Shear	= 82.16	43.82 psi
Toe Reinforcing	= # 5 @ 8.00 in	
Heel Reinforcing	= None Spec'd	
Key Reinforcing	= # 4 @ 18.00 in	
Footing Torsion, Tu	=	0.00 ft-lbs
Footing Allow. Torsion, phi Tu	=	0.00 ft-lbs

If torsion exceeds allowable, provide supplemental design for footing torsion.

Other Acceptable Sizes & Spacings

Toe: #4@ 10.52 in, #5@ 16.31 in, #6@ 23.16 in, #7@ 31.58 in, #8@ 41.58 in, #9@ 5
 Heel: phiMn = phi'5'lambda'sqrt(fc)'Sm
 Key: No key defined

Min footing T&S reinf Area	0.76 in ²
Min footing T&S reinf Area per foot	0.22 in ² /ft
If one layer of horizontal bars:	If two layers of horizontal bars:
#4@ 11.11 in	#4@ 22.22 in
#5@ 17.22 in	#5@ 34.44 in
#6@ 24.44 in	#6@ 48.89 in

(NORTH WALL)
Cantilevered Retaining Wall

RetainPro (c) 1987-2019, Build 11.20.03.31
 License : KW-06061521
 License To : D.S. Engineering

Code: IBC 2018,ACI 318-14,TMS 402-16

Summary of Overturning & Resisting Forces & Moments

ItemOVERTURNING.....			RESISTING.....		
	Force lbs	Distance ft	Moment ft-#		Force lbs	Distance ft	Moment ft-#
HL Act Pres (ab water tbl)	1,365.5	2.94	4,020.6	Soil Over HL (ab. water tbl)	293.3	3.33	977.8
HL Act Pres (be water tbl)				Soil Over HL (bel. water tbl)		3.33	977.8
Hydrostatic Force				Watre Table			
Buoyant Force =				Sloped Soil Over Heel =			
Surcharge over Heel =				Surcharge Over Heel =			
Surcharge Over Toe =				Adjacent Footing Load =			
Adjacent Footing Load =				Axial Dead Load on Stem =	1,840.0	2.83	1,955.0
Added Lateral Load =				* Axial Live Load on Stem =	1,150.0	2.83	3,258.3
Load @ Stem Above Soil =	-7.0	9.08	-63.6	Soil Over Toe =	275.0	1.25	343.8
Seismic Earth Load =	72.6	4.42	320.8	Surcharge Over Toe =			
				Stem Weight(s) =	850.0	2.83	2,408.3
				Earth @ Stem Transitions =			
Total	= 1,431.1	O.T.M.	= 4,277.9	Footing Weight =	437.5	1.75	765.6
				Key Weight =			
				Vert. Component =			
Resisting/Overturning Ratio		=	1.51	Total	= 2,545.8 lbs	R.M.	= 6,450.5
Vertical Loads used for Soil Pressure =		3,695.8	lbs				

* Axial live load NOT included in total displayed, or used for overturning resistance, but is included for soil pressure calculation.

If seismic is included, the OTM and sliding ratios may be 1.1 per section 1807.2.3 of IBC.

Vertical component of active lateral soil pressure IS NOT considered in the calculation of Sliding Resistance.

Vertical component of active lateral soil pressure IS NOT considered in the calculation of Overturning Resistance.

Tilt

Horizontal Deflection at Top of Wall due to settlement of soil

(Deflection due to wall bending not considered)

Soil Spring Reaction Modulus 250.0 pci
 Horizontal Defl @ Top of Wall (approximate only) 0.105 in

The above calculation is not valid if the heel soil bearing pressure exceeds that of the toe, because the wall would then tend to rotate into the retained soil.

(NORTH ASSEY)

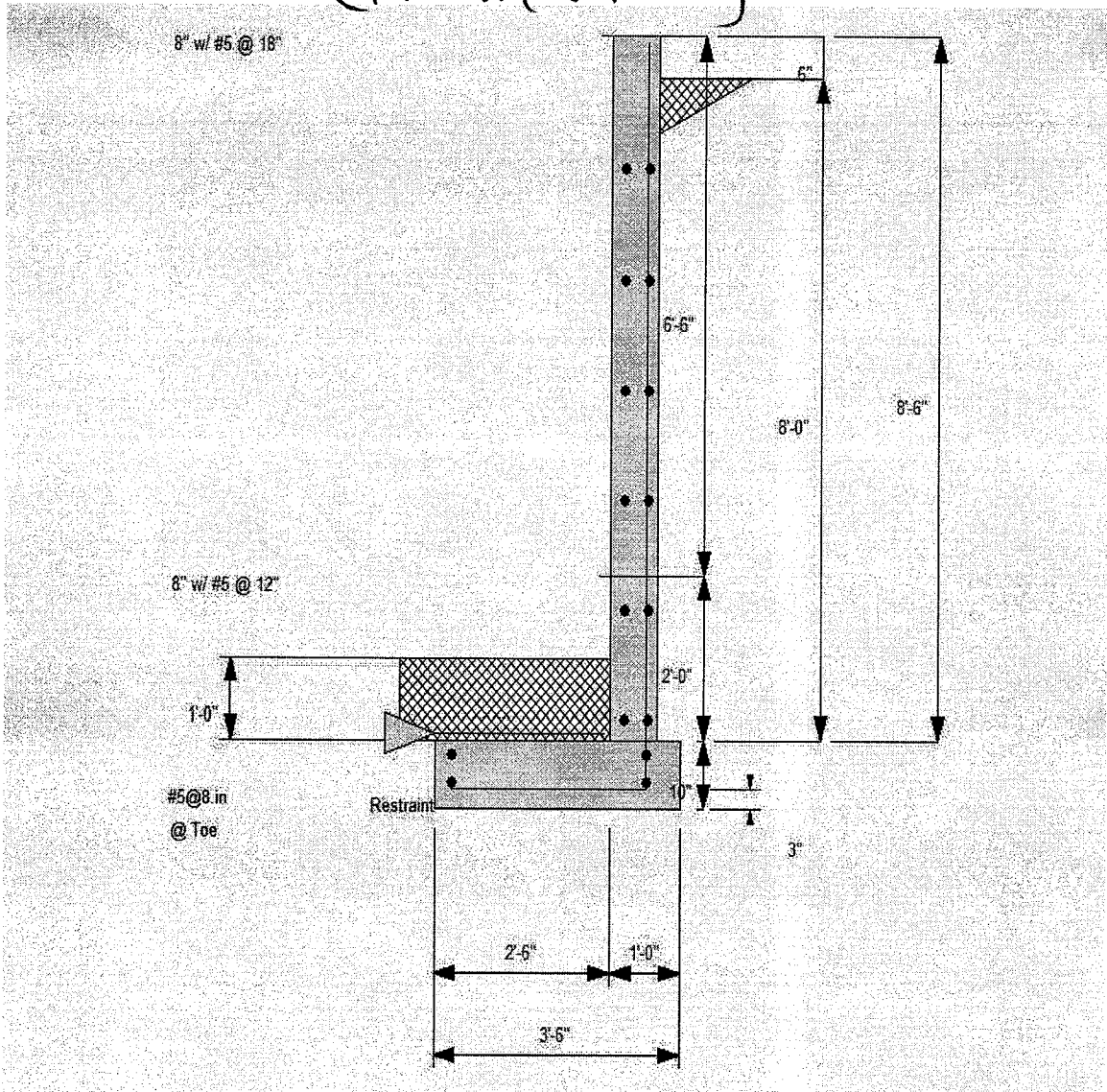

Search Information

Address: 6950 SE Maker St, Mercer Island, WA 98040, USA
 Coordinates: 47.5786938, -122.2436788
 Elevation: 233 ft
 Timestamp: 2022-05-09T08:26:45.273Z
 Hazard Type: Seismic
 Reference Document: ASCE7-16
 Risk Category: II
 Site Class: D

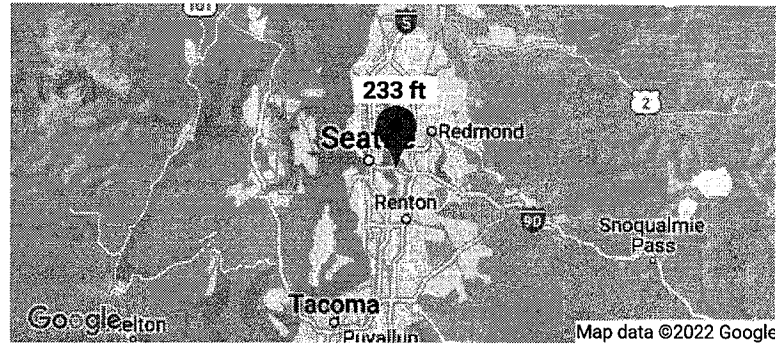

Basic Parameters

Name	Value	Description
S _s	1.414	MCE _R ground motion (period=0.2s)
S ₁	0.492	MCE _R ground motion (period=1.0s)
S _{MS}	1.414	Site-modified spectral acceleration value
S _{M1}	* null 0.89	Site-modified spectral acceleration value = $F_v S_1 = 1.808 \times 0.492 = 0.89$
S _{DS}	0.943	Numeric seismic design value at 0.2s SA
S _{D1}	* null 0.593	Numeric seismic design value at 1.0s SA = $\frac{2}{3} S_{M1} = 0.593$

* See Section 11.4.8

Additional Information

Name	Value	Description
SDC	* null D	Seismic design category
F _a	1	Site amplification factor at 0.2s
F _v	* null 1.808	Site amplification factor at 1.0s
CR _s	0.902	Coefficient of risk (0.2s)
CR ₁	0.897	Coefficient of risk (1.0s)
PGA	0.605	MCE _G peak ground acceleration
F _{PGA}	1.1	Site amplification factor at PGA
PGA _M	0.666	Site modified peak ground acceleration
T _L	6	Long-period transition period (s)
S _{sRT}	1.414	Probabilistic risk-targeted ground motion (0.2s)
S _{sUH}	1.567	Factored uniform-hazard spectral acceleration (2% probability of exceedance in 50 years)
S _{sD}	3.44	Factored deterministic acceleration value (0.2s)
S _{1RT}	0.492	Probabilistic risk-targeted ground motion (1.0s)
S _{1UH}	0.549	Factored uniform-hazard spectral acceleration (2% probability of exceedance in 50 years)
S _{1D}	1.386	Factored deterministic acceleration value (1.0s)
PGA _d	1.179	Factored deterministic acceleration value (PGA)

LI

Design Lateral Seismic Load per "IBC 2018' & 'ASCE/SEI 7-16":

The total design lateral seismic force is determined from:

$V = C_s \times W = 0.1015 \times W = 8670 \text{ lb.} \quad : \text{ ASD}$

- From:
- $S_s = 1.414 \text{ g}$ (=0.2 sec response) Seismic Design Category : **D**
 - $S_1 = 0.492 \text{ g}$ (=1.0 sec response) Occupancy Category : **II**
 - $F_a = 1.000$ (=site Coefficients: site classification 'D') Seismic Use Group : **I**
 - $F_v = 1.808$ (=site Coefficients: site classification 'D')
 - $S_{MS} = 1.414$ (= $F_a \times S_s$)
 - $S_{M1} = 0.890$ (= $F_v \times S_1$)
 - $S_{DS} = 0.943$ [= $S_{MS} \times (2/3)$]
 - $S_{D1} = 0.593$ [= $S_{M1} \times (2/3)$]
 - $C_t = 0.020$ $T_L = 6.00 \text{ sec.}$
 - $h_n = 21.00 \text{ ft.}$ (=Mean Height of Roof) $T = 0.20 \text{ sec.}$
 - $I_e = 1.00$
 - $R = 6.50$
 - $C_s = 0.1015$ (= $S_{DS} / (R/I_e) \times 0.7$) : **ASD**
 - $W = 85400 \text{ lb.}$ (=Included Exterior & Interior Partition Wall)

ASCE/SEI 7-16' Section 12.8.1 has a requirement that V be not less than 0.01 W
BUT not more than $\{(S_{D1} \times I) / (R \times T)\} \times W$

Check: $(0.01) \times W < V < \{(S_{D1} \times I) / (R \times T)\} \times W$
598 lb. < **V** < 27798 lb. : **O. K.**

Distribution of Base Shear (ASD):

Level	W_i (lb)	h_i (ft)	$(W_i)(h_i)$	$(W_i h_i) / \text{Sum}(W_i h_i)$	F_x	Sum (F_x)
Roof	46900	21.00	984900	0.709	6147	6147 lb.
2nd Floor	38500	10.50	404250	0.291	2523	8670 lb.
	85400		1389150	1.000		

From Roof : $(25+4) \times 35 \times 28 + (20+4) \times 35 \times 22 = 46900 \#$

2nd Floor : $(12+10) \times 35 \times 60 = 38500 \#$

Diaphragm Load (ASD):

Level	F_i (lb)	sum: F_i	W_i	sum: F_i /sum: W_i	Adjust	F_{px}
Roof	6147	6147	46900	0.131	0.132	6191 lb.
2nd Floor	2523	8670	38500	0.102	0.132	5082 lb.
			85400			

$F_x(\text{max}) = 0.4 S_{DS} I_e W_{px} (0.7) = 0.264$
 $F_x(\text{min}) = 0.2 S_{DS} I_e W_{px} (0.7) = 0.132$

1st Floor : $(12+10) \times 35 \times 60 \times 0.1015 = 3020 \#$
(SUPPORT BY CONC. WALL)

Search Information

Address: 6950 SE Maker St, Mercer Island, WA 98040, USA
 Coordinates: 47.5786938, -122.2436788
 Elevation: 233 ft
 Timestamp: 2022-05-09T18:58:24.599Z
 Hazard Type: Wind

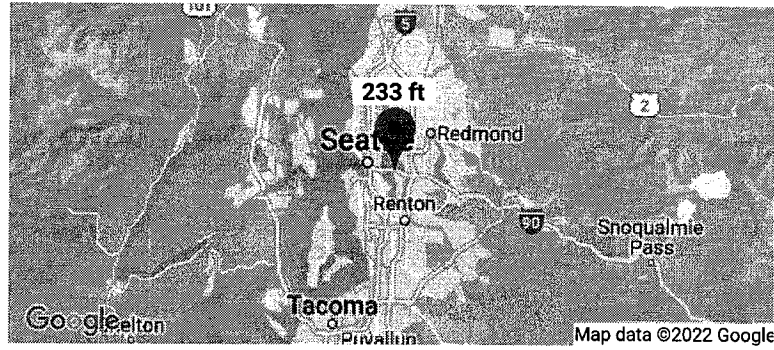

ASCE 7-16

MRI 10-Year	67 mph
MRI 25-Year	73 mph
MRI 50-Year	78 mph
MRI 100-Year	83 mph
Risk Category I	92 mph
Risk Category II	97 mph
Risk Category III	104 mph
Risk Category IV	108 mph

ASCE 7-10

MRI 10-Year	72 mph
MRI 25-Year	79 mph
MRI 50-Year	85 mph
MRI 100-Year	91 mph
Risk Category I	100 mph
Risk Category II	110 mph
Risk Category III-IV	115 mph

ASCE 7-05

ASCE 7-05 Wind Speed 85 mph

The results indicated here DO NOT reflect any state or local amendments to the values or any delineation lines made during the building code adoption process. Users should confirm any output obtained from this tool with the local Authority Having Jurisdiction before proceeding with design.

Disclaimer

Hazard loads are interpolated from data provided in ASCE 7 and rounded up to the nearest whole integer. Per ASCE 7, islands and coastal areas outside the last contour should use the last wind speed contour of the coastal area – in some cases, this website will extrapolate past the last wind speed contour and therefore, provide a wind speed that is slightly higher. NOTE: For queries near wind-borne debris region boundaries, the resulting determination is sensitive to rounding which may affect whether or not it is considered to be within a wind-borne debris region.

Mountainous terrain, gorges, ocean promontories, and special wind regions shall be examined for unusual wind conditions.

While the information presented on this website is believed to be correct, ATC and its sponsors and contributors assume no responsibility or liability for its accuracy. The material presented in the report should not be used or relied upon for any specific application without competent examination and verification of its accuracy, suitability and applicability by engineers or other licensed professionals. ATC does not intend that the use of this information replace the sound judgment of such competent professionals, having experience and knowledge in the field of practice, nor to substitute for the standard of care required of such professionals in interpreting and applying the results of the report provided by this website. Users of the information from this website assume all liability arising from such use. Use of the output of this website does not imply approval by the governing building code bodies responsible for building code approval and interpretation for the building site described by latitude/longitude location in the report.

110 MPH, EXPOSURE 'B', K_z = 1.38

PER FIG 26.8-1
(EXPOSURE 'C')

$H/L_n : 230/400 = 0.58 \quad k_1 = 0.43$
 $X/L_n : 35/400 = 0.10 \quad k_2 = 0.98$
 $Z/L_n : 25/400 = 0.06 \quad k_3 = 0.90$

$K_{zt} = (1 + k_1 k_2 k_3)^2 \times 0.7$
 $= 1.33$
SAY $K_{zt} = 1.38$

27 Directional Procedure, Part 1: Enclosed and Partially Enclosed Rigid Buildings. (All Heights)
 27.4. MWFRS

1.0

Velocity pressure $q_z = .00256 K_z K_{zt} K_d V^2 K_e$ (27.3-1) **26.10-1**
 Exposure B Roof Height $h = 31.5$ feet

Roof Pitch = 0.00 : 12 **26.10-1**
 Exposure coefficient $K_z =$ Section 27.3-1, shall be determined from Table 27.3-1

Topography factor $K_{zt} = 1.38$ 26.8.2, Figure 26.8-1

Directionality factor $K_d = 0.85$ 26.6, Table 26.6-1

Building & Structure Risk Category = II, standard IBC T-1604.5

Wind Speed $V = 110$ mph Fig. 26.5-1B, MRI = 700 yrs

$q_z = 36.33 K_z$ psf

Internal Pressure Coefficient (GC_{pi}) = ± 0.18

Gust effect factor $G = 0.85$

Pressures for MWFRS $p = qGC_p - q_i(GC_{pi})$ (27.3-1)

Wall and Roof External Pressure Coefficients C_p from Fig. 27.4-1

Wind Normal to Ridge (\perp to 35) $L/B = 0.70$ $h/L = 31.5/35 = 0.90$ $\theta = 0.0$

Windward wall $C_p = 0.80$ Windward roof $C_p =$

Leeward wall $C_p = -0.50$ for $L/B = 0.70$ Leeward roof $C_p =$

Side wall $C_p = -0.70$ or Roof $C_p = -1.22$ 0.86

Wind Parallel to Ridge (\perp to 50) $L/B = 1.43$

Windward wall $C_p = 0.80$ $h/L = 31.5/50 = 0.63$

Leeward wall $C_p = -0.41$ for $L/B = 1.43$ Roof $C_p = -0.90$

Side wall $C_p = -0.70$ for dist 0 16 32

Table 26.13-1, for Enclosed Building

~~26.9~~ **26.11-1** (27.3-1)

-26.8 18.9 -14.4812124757381 -13.6035632347843

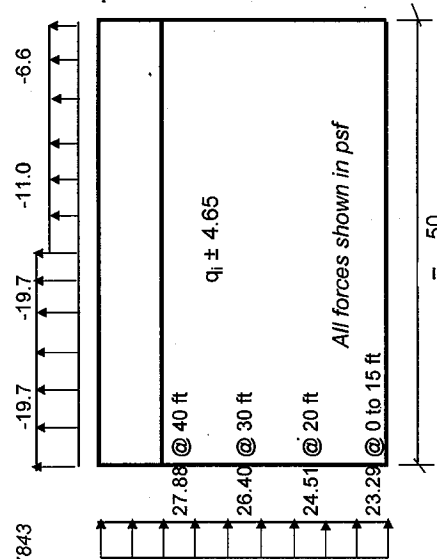
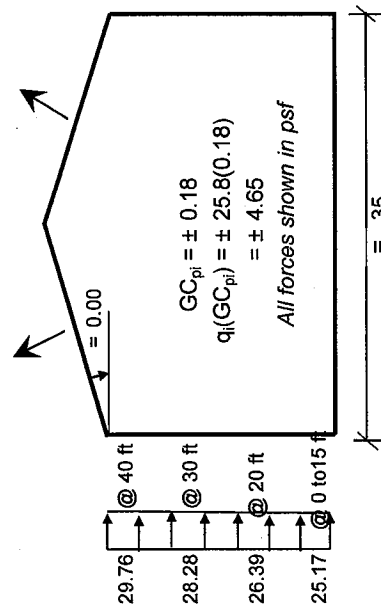

$p = qGC_p - q_i (GC_{pi})$ (27.7-1) For Exp B
 $q = q_z$ for windward at height z $z_g = 1200$ $\alpha = 7.0$
 $q = q_h$ for leeward wall, side wall and roof @31.5 ft $K_z = 2.01(z/z_g)^{2/\alpha}$
 $q_i = q_h$ for enclosed building @31.5 ft $K_z (\text{min}) = 2.01(15/z_g)^{2/\alpha}$

Roof Ht, h = 31.5 ft		Normal to Ridge		Parallel to ridge		Parallel to ridge	
Height	K_h	q_h	C_p	$q_h GC_p$	C_p	$q_h GC_p$	$q_h GC_p$
Leeward wall all	0.710	25.81	-0.5	-10.97	-0.41	-9.09	
Side wall all	0.710	25.81	-0.70	-15.36	-0.70	-15.36	
Roof		Or					
ww			-1.22	-26.8	-0.90	-19.75	fr 0 - 15.75
Lw			0.86	18.9	-0.90	-19.75	fr > 15.75
			-0.66	-14.48	-0.50	-10.97	fr 31.5-63
			-0.62	-13.60	-0.30	-6.58	fr 63

		Normal to Ridge		Parallel to ridge		Parallel to ridge	
$z, Ht. (ft)$	K_z	q_z	C_p	$p = -q_z GC_p$	C_p	$p = q_z GC_p$	$WW+LW$
Windward wall							
0 to 15	0.575	20.88	0.80	14.20	0.80	14.20	23.29
20.0	0.624	22.67	0.80	15.42	0.80	15.42	24.51
30.0	0.701	25.46	0.80	17.31	0.80	17.31	26.40
40.0	0.761	27.64	0.80	18.79	0.80	18.79	27.88

GRIDS

$F_{TOP} = 2230\# + 1790\# = 4020\#$

Table 27.5-1 : 30'

$F_{2ND} = 4060\# (\Sigma 8080\#)$

$F_{1ST} = 2680\# (\Sigma 10760\#)$

$(\frac{19.6+16.9}{2}) \times 2.25 \times 2.5 \times 21 = 2160\# \times 1.38 = 2980\#$
 H9-27.5-2
 $\textcircled{S} \times 0.6 = 1790\#$

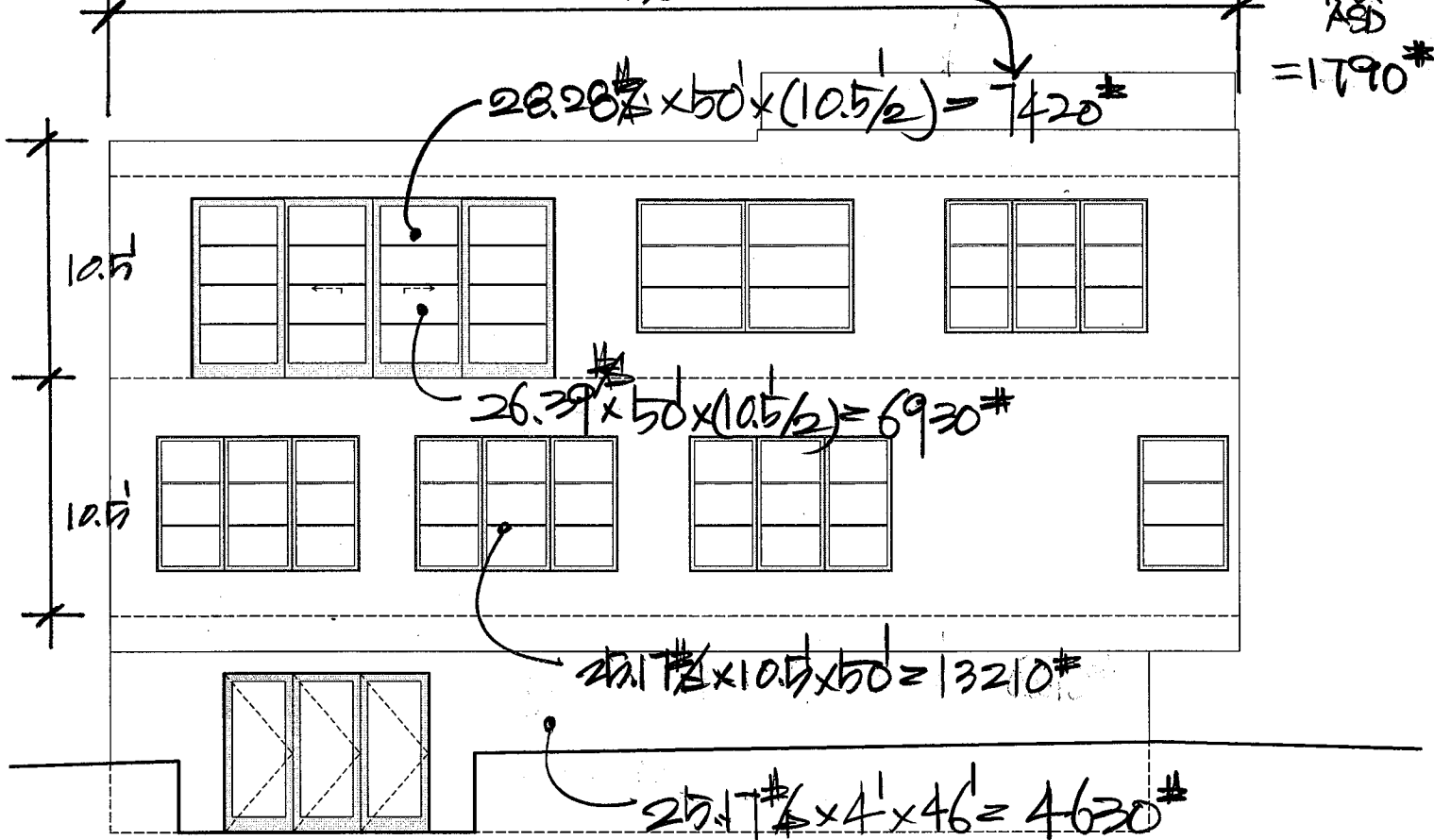

WEST ELEVATION

0 4

SCALE: 1/4" = 1'-0"

GRID N

$F_{TOP} = 7420\# / 2 = 3710\# \times 0.6 = 2230\#$

$F_{2ND} = 6930\# / 2 + 13210\# / 4 = 6770\# \times 0.6 = 4060\#$

$F_{1ST} = 13210\# / 4 + 4630\# / 4 = 4460\# \times 0.6 = 2680\#$
 $(\Sigma 6290\#)$
 $(\Sigma 8970\#)$ L6

Table 27.5-1

$$\left(\frac{19.6 + 16.9}{2}\right) \times \frac{2.25 \times 2.5 \times 35}{14} = 359 \frac{1}{2} \times 1.38 \times 0.6 = 2970 \frac{1}{2}$$

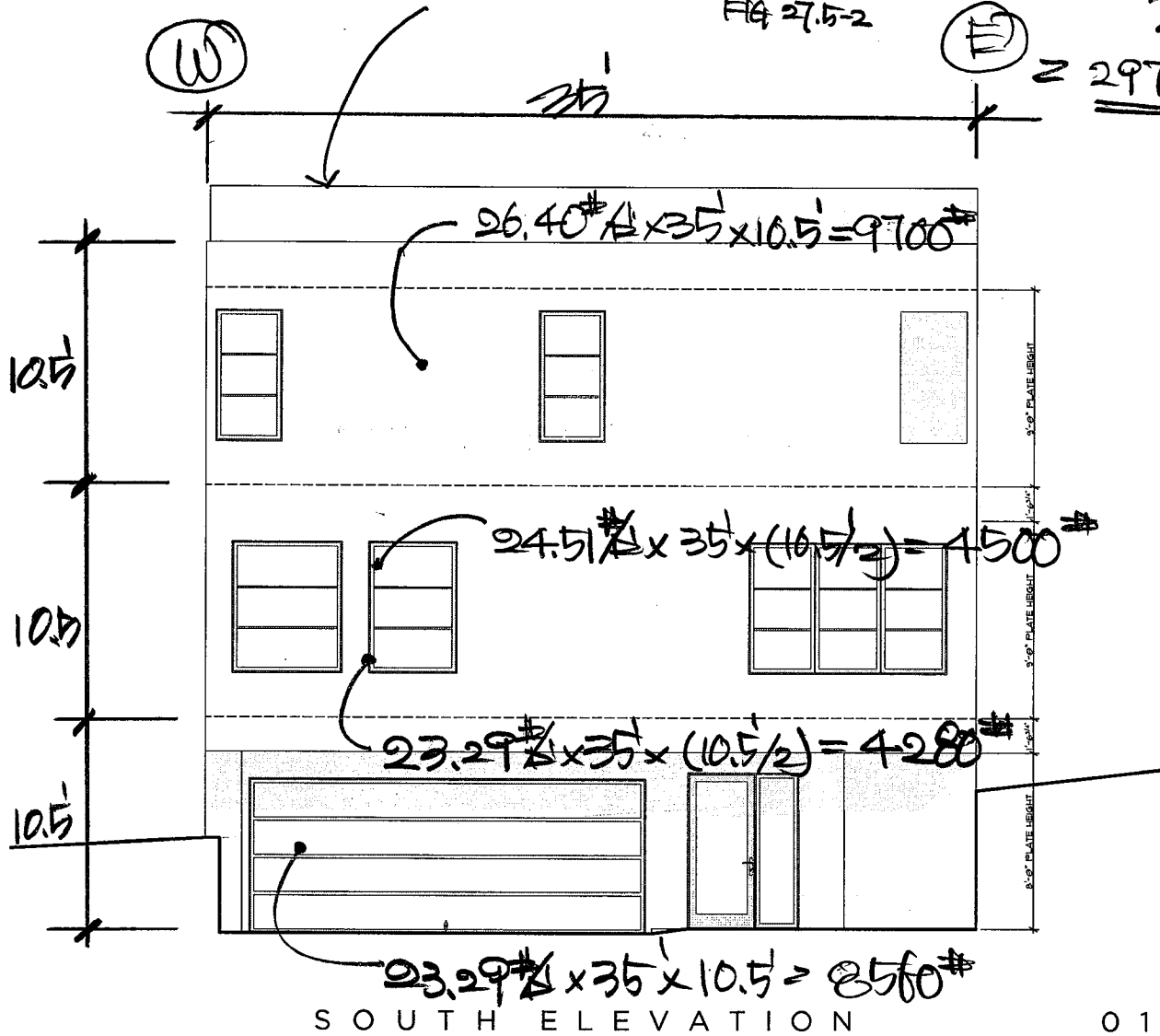

SCALE: 1/4" = 1'-0"

01

GRID (E) & (W):

$$F_{\text{TOP}} = 9700 \frac{1}{4} = 2425 \times 0.6 = 1455 + 2910 \frac{1}{2} = 2940$$

$$F_{\text{MID}} = 9700 \frac{1}{4} + 4500 \frac{1}{2} = 4675 \times 0.6 = 2805 \quad (\Sigma 5745)$$

$$F_{\text{1ST}} = 4280 \frac{1}{4} + 8560 \frac{1}{4} = 3220 \times 0.6 = 1932 \quad (\Sigma 7670)$$

• V = ~~CELS~~
 • F = WIND
 (W)

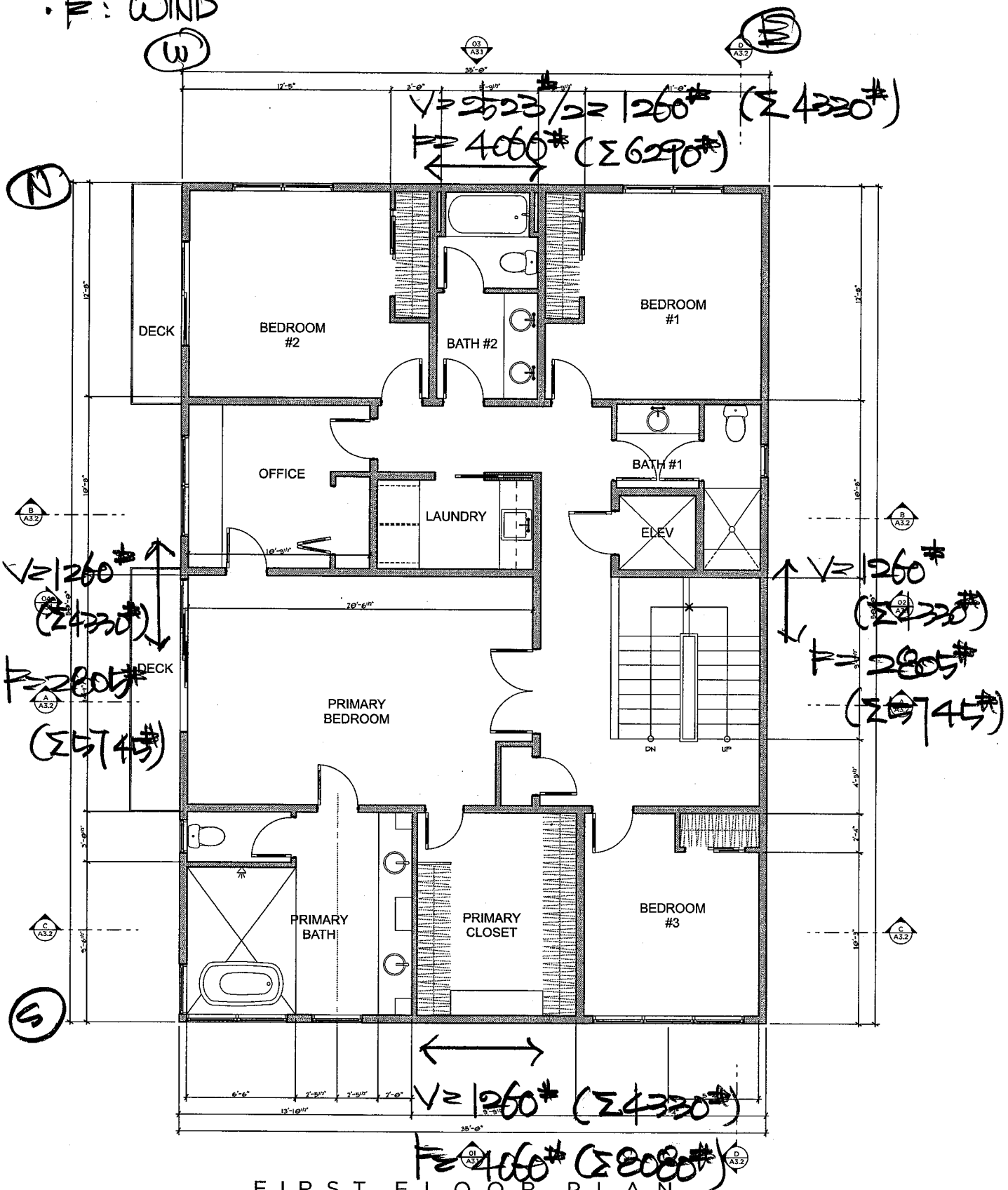

FIRST FLOOR PLAN

SCALE: 1/4" = 1'-0"

(2ND)



V: ~~CLAS~~
 P: WIND

$$V = 3020 \frac{\#}{2} = 1510 \# (\Sigma 5840 \#)$$

$$P = 2680 \# (\Sigma 8970 \#)$$

(W)

(N)

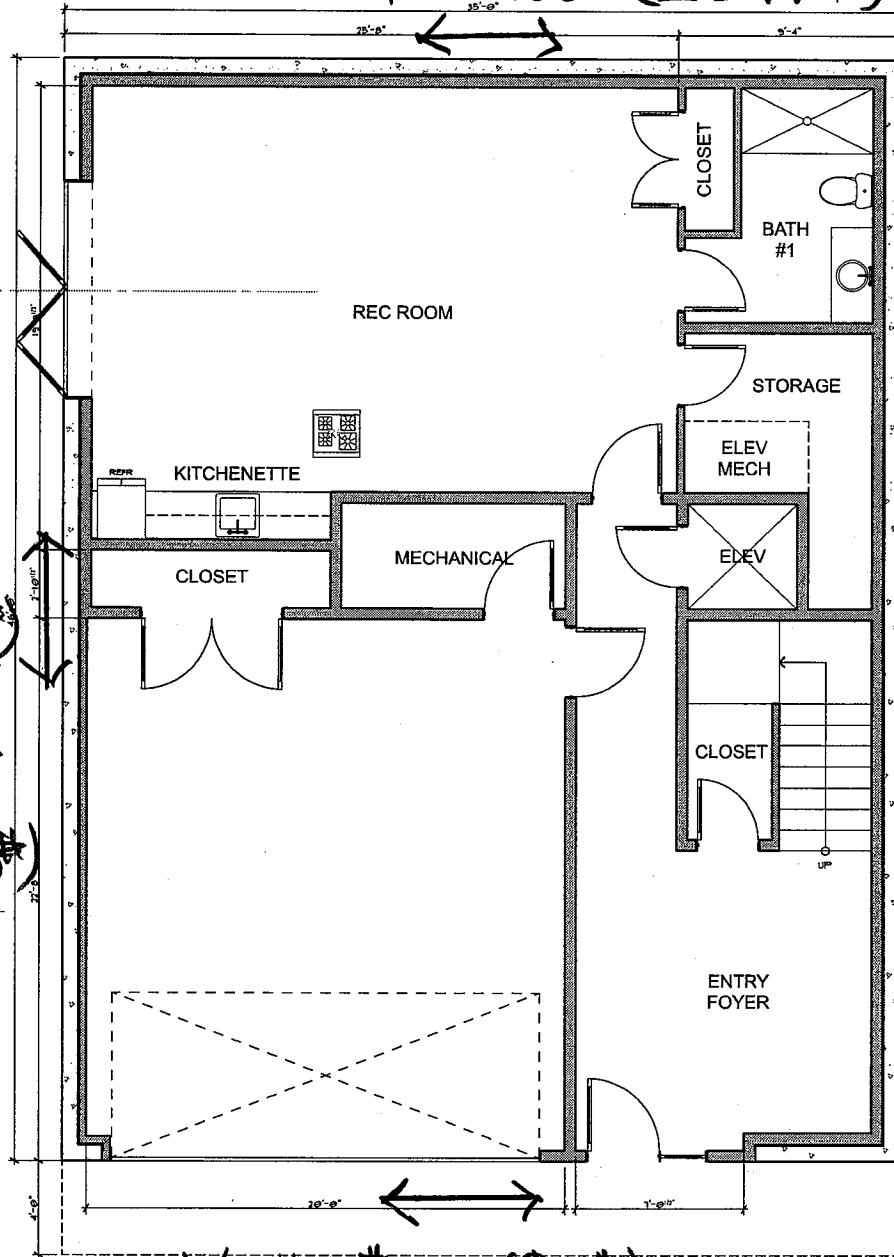

$$V = 1510 \#$$

$$(\Sigma 5840 \#)$$

$$P = 1925 \#$$

$$(\Sigma 7670 \#)$$

$$V = 1510 \#$$

$$(\Sigma 5840 \#)$$

$$P = 1925 \#$$

$$(\Sigma 7670 \#)$$

$$V = 1510 \# (\Sigma 6920 \#)$$

B A S E M E N T P L A N

$$P = 2680 \# (\Sigma 10760 \#)$$

$$1510 \# + 1.25 \times 4330 \#$$

(FIRST)

Table 4.3A Nominal Unit Shear Capacities for Wood-Frame Shear Walls 1-3,6,7

Wood-based Panels⁴

Sheathing Material	Minimum Nominal Panel Thickness (in.)	Minimum Fastener Penetration in Framing Member or Blocking (in.)	Fastener Type & Size	A SEISMIC												B WIND																			
				Panel Edge Fastener Spacing (in.)						Panel Edge Fastener Spacing (in.)						Panel Edge Fastener Spacing (in.)																			
				6		4		3		2		6		4		3		2		6		4		3		2									
				V _e (plf)	G _s (kips/in.)	V _e (plf)	G _s (kips/in.)	V _e (plf)	G _s (kips/in.)	V _e (plf)	G _s (kips/in.)	V _e (plf)	G _s (kips/in.)	V _e (plf)	G _s (kips/in.)	V _e (plf)	G _s (kips/in.)	V _e (plf)	G _s (kips/in.)	V _e (plf)	G _s (kips/in.)	V _e (plf)	G _s (kips/in.)	V _e (plf)	G _s (kips/in.)										
Wood Structural Panels - Structural ^{4,5}	5/16	1-1/4	Nail (common or galvanized box) 6d	OSB	PLY	OSB	PLY	OSB	PLY	OSB	PLY	OSB	PLY	OSB	PLY	OSB	PLY	OSB	PLY	OSB	PLY	OSB	PLY												
	3/8	1-3/8		400	13	10	600	18	13	780	23	18	1020	35	22	560	840	1090	1430	460	19	14	720	24	17	920	30	20	1220	43	24	645	1010	1290	1710
	7/16 ²	15/32		510	16	13	790	21	16	1010	27	19	1340	40	24	715	1105	1415	1875	560	14	11	860	18	14	1100	24	17	1460	37	23	785	1205	1540	2045
Wood Structural Panels - Sheathing ^{4,5}	5/16	1-1/2	Nail (common or galvanized box) 6d	OSB	PLY	OSB	PLY	OSB	PLY	OSB	PLY	OSB	PLY	OSB	PLY	OSB	PLY	OSB	PLY	OSB	PLY	OSB	PLY												
	3/8	1-3/8		360	13	9.5	540	18	12	700	24	14	900	37	18	505	755	980	1260	400	15	11	820	31	17	1080	45	20	615	895	1150	1485			
	7/16 ²	15/32		440	17	12	640	25	15	820	31	17	1080	45	20	670	980	1260	1640	520	13	10	760	19	13	980	25	15	1280	39	20	730	1065	1370	1790
Plywood Siding	5/16	1-1/2	Nail (galvanized casing) 6d	OSB	PLY	OSB	PLY	OSB	PLY	OSB	PLY	OSB	PLY	OSB	PLY	OSB	PLY	OSB	PLY	OSB	PLY	OSB	PLY												
	3/8	1-3/8		280	13	16	420	16	16	550	17	17	720	21	21	390	590	770	1010	320	16	16	480	18	18	620	20	20	450	670	870	1150			
	3/8	1-3/8		320	16	16	480	18	18	620	20	20	820	22	22	450	670	870	1150	240	15	15	360	17	19	460	19	19	600	22	22	335	505	645	840
Particleboard Sheathing - (M-S "Exterior Glue" and M-2 "Exterior Glue")	3/8	1-1/2	Nail (common or galvanized box) 6d	OSB	PLY	OSB	PLY	OSB	PLY	OSB	PLY	OSB	PLY	OSB	PLY	OSB	PLY	OSB	PLY	OSB	PLY	OSB	PLY												
	3/8	1-3/8		260	18	18	380	20	20	480	21	21	630	23	23	365	530	670	880	280	18	18	420	20	22	700	24	24	390	590	755	980			
	1/2	1-1/2		370	21	21	550	23	23	720	24	24	920	25	25	520	770	1010	1290	400	21	21	610	23	23	790	24	24	1040	26	26	560	855	1105	1455
Structural Fiberboard Sheathing	1/2	1-1/2	Nail (galvanized roofing) 11 ga. galv. roofing nail (0.120" x 1-1/2" long x 7/16" head)	OSB	PLY	OSB	PLY	OSB	PLY	OSB	PLY	OSB	PLY	OSB	PLY	OSB	PLY	OSB	PLY	OSB	PLY	OSB	PLY												
	25/32	1-1/2		340	4.0	4.0	460	5.0	5.0	520	5.5	5.5	520	5.5	5.5	475	645	730	930	340	4.0	4.0	460	5.0	5.0	520	5.5	5.5	475	645	730				

- Nominal unit shear capacities shall be adjusted in accordance with 4.3.3 to determine ASD allowable unit shear capacity and LRFD factored unit resistance. For general construction requirements see 4.3.6. For specific requirements, see 4.3.7.1 for wood structural panel shear walls, 4.3.7.2 for particleboard shear walls, and 4.3.7.3 for fiberboard shear walls. See Appendix A for common and box nail dimensions.
- Shears are permitted to be increased to values shown for 15/32 inch (nominal) sheathing with same nailing provided (a) studs are spaced a maximum of 16 inches on center, or (b) panels are applied with long nailing across studs.
- For species and grades of framing other than Douglas-Fir-Larch or Southern Pine, reduced nominal unit shear capacities shall be determined by multiplying the tabulated nominal unit shear capacity by the Specific Gravity Adjustment Factor = $[1 - (0.5 - G)]$, where G = Specific Gravity of the framing lumber from the NDS (Table 12.3.3A). The Specific Gravity Adjustment Factor shall not be greater than 1.
- Apparent shear stiffness values G_s are based on nail slip in framing with moisture content less than or equal to 19% at time of fabrication and panel stiffness values for shear walls constructed with either OSB or 3-ply plywood panels. When 4-ply or 5-ply plywood panels or composite panels are used, G_s values shall be permitted to be multiplied by 1.2.
- Where moisture content of the framing is greater than 19% at time of fabrication, G_s values shall be multiplied by 0.5.
- Where panels are applied on both faces of a shear wall and nail spacing is less than 6" on center on either side, panel joints shall be offset to fall on different framing members as shown below. Alternatively, the width of the nailed face of framing members shall be 3" nominal or greater at adjoining panel edges and nails at all panel edges shall be staggered.
- Galvanized nails shall be hot-dipped or tumbled.

Reliability/Redundancy Factor: SEISMIC

0.6D + 0.6W (Eq. 16-15)
 0.6D + 0.7E (Eq. 16-16) & E = Q_E - 0.2 S_{DS} D
 ----> 0.47 D + 0.7 Q_E

Use R.F. = 1.00 S_{DS} = 0.943

SEISMIC:

@ Grid 'N': Roof: V = 3070 # L = 25.5'

V_{wall} = 3070 lb.
 V_{wall}' = 3070 lb (V_{wall} x R.F.)
 L = 25.50 ft.
 H = 10.50 ft.
 V_{shear} = 120 plf
 T=C= 1289 lb.

<TFP

WIND:

@ Grid 'N': Roof: F = 2230 # L = 25.5'

F_{wall} = 2230 lb.
 L = 25.50 ft.
 H = 10.50 ft.
 V_{shear} = 87 plf
 T=C= 937 lb.

<TFP

SEISMIC:

@ Grid 'N': 2nd Fir: V = 4330 # L = 17'

V_{wall} = 4330 lb.
 V_{wall}' = 4330 lb (V_{wall} x R.F.)
 L = 17.00 ft.
 H = 10.50 ft.
 V_{shear} = 255 plf
 T=C= 2755 lb.

<W6

WIND:

@ Grid 'N': 2nd Fir: F = 6290 # L = 17'

F_{wall} = 6290 lb.
 L = 17.00 ft.
 H = 10.50 ft.
 V_{shear} = 370 plf
 T=C= 4003 lb.

<W6

SEISMIC:

@ Grid 'N': 1st Fir: V = 5840 # L = 35' (8" Concrete Shearwall)

V_{wall} = 5840 lb.
 L = 35.00 ft.
 H = 10.50 ft.
 V_{shear} = 166.8 plf
 T=C= 5840 lb.

V = 2970 # / 5ft

= 256 # x 10' -> 8" conc wall w/ #5 @ 16" o.c

(HAPP)

Handwritten notes: #s: [248# + 12#(23/2) + 60#] (17/2) = 464# x 0.47 = 2082# > 1289#
 (2340#) NO UPLIFT x 0.60 = 2658# > 937#

Handwritten notes: #s = [248# + 12#(23/2) + 60#] (17/2) = 464# x 0.47 = 2082#
 x 0.60 = 2785# T_{NET} = 574#
 x 0.60 = 2785# T_{NET} = 1218#

SEISMIC:
 @ Grid 'S': Roof: V = 3070 # 3070 #
 L = 21'

$V_{wall} = 3070$ lb.
 $V_{wall}' = 3070$ lb ($V_{wall} \times R.F.$)
 L = 21.00 ft.
 H = 10.50 ft.
 $V_{shear} = 146$ plf
 T=C = 1572 lb.

$Req = [50 \# (1\frac{1}{2}) + 60 \#] (2\frac{1}{2}) = 2415 \#$
 $(= 2300 \#)$

$Req = [230 \# + 12 \# (1\frac{1}{2}) + 60 \#] (3.75/2) = 2695 \#$
 $(= 2600 \#)$

WIND:
 @ Grid 'S': Roof: F = 4020 # 4020 #
 L = 21'

$F_{wall} = 4020$ lb.
 L = 21.00 ft.
 H = 10.50 ft.
 $V_{shear} = 191$ plf
 T=C = 2059 lb.

$T_{NET} = 437 \#$
 $T_{NET} = 610 \#$

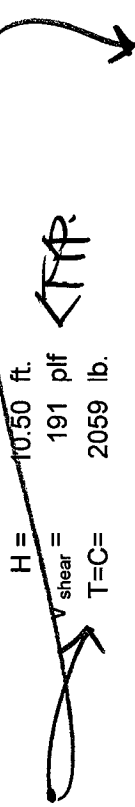

SEISMIC:
 @ Grid 'S': 2nd Fir: V = 4330 # 4330 #
 L = 13.75'

$V_{wall} = 4330$ lb.
 $V_{wall}' = 4330$ lb ($V_{wall} \times R.F.$)
 L = 13.75 ft.
 H = 10.50 ft.
 $V_{shear} = 315$ plf
 T=C = 3431 lb.

$Req = [230 \# + 12 \# (1\frac{1}{2}) + 60 \#] (3.75/2) = 2695 \#$
 $T_{NET} = 2164 \#$
 $T_{NET} = 4786 \#$

WIND:
 @ Grid 'S': 2nd Fir: F = 8080 # 8080 #
 L = 13.75'

$F_{wall} = 8080$ lb.
 L = 13.75 ft.
 H = 10.50 ft.
 $V_{shear} = 588$ plf
 T=C = 6403 lb.

SEISMIC:
 @ Grid 'S': 1st Fir: V = 6920 # 6920 #
 L = 6' (8" Concrete Shearwall)

$V_{Adj} = 6920 \# (6.5/5)$
 $= 9000 \#$

WIND:
 @ Grid 'S': 1st Fir: F = 10760 # 10760 #
 L = 6' (8" Concrete Shearwall)

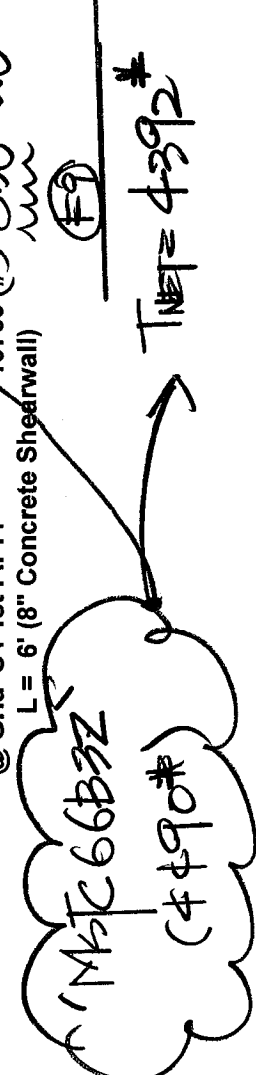

Concrete Shear Wall

File: examples.ec6
 Software copyright ENERCALC, INC. 1983-2020; Build:12.20.8.24
 D.S. ENGINEERING PC

Lic. #: KW-06010224

DESCRIPTION: Concrete Shear Wall (South)

Code References

Calculations per ACI 318-14, IBC 2018, CBC 2019, ASCE 7-16

Load Combinations Used : IBC 2018

General Information

Wall Material	CONCRETE	Material Properties			
Sds	0.9430	fc	3.0 ksi	Ec	3,120.0 ksi
		fy	60.0 ksi	Ev	1,248.0 ksi
		Density	150.0 pcf	Phi - Shear	0.650

Wall Data

	<u>Bottom</u>
Analysis Height	0.00 ft
Wall Offset (datum)	ft
Wall Length	6 ft
Wall Thickness	8.0 in
Structural Depth	5.750 ft

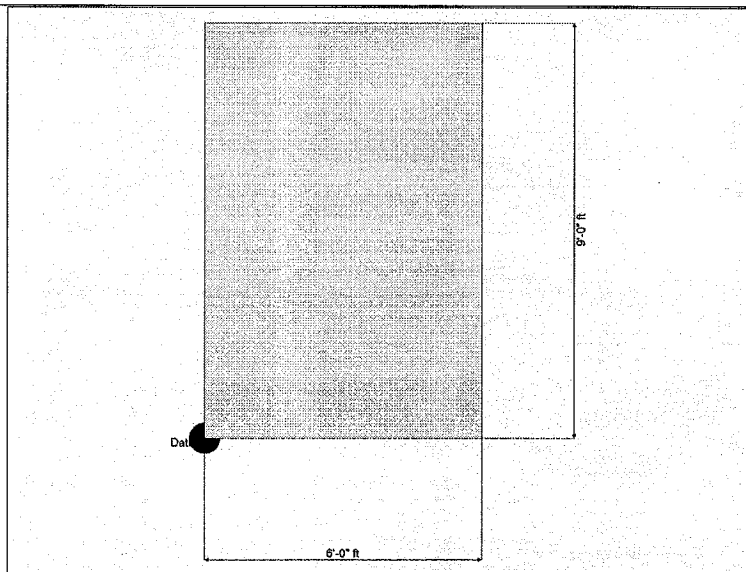

Applied Distributed Vertical Loads

Load Location (ft)			Load Magnitude (kips)				
Start Location	End Location	Height of Application	Dead Load	Roof Live Load	Live Load	Snow Load	Earth Load
0.0	6.0	9.0	0.0940	0.0	0.3350	0.0	0.0

Applied Concentrated Lateral Loads

Load "Y" Location (ft)	Load Magnitude (kips)					
	Dead Load	Roof Live Load	Floor Live Load	Wind Load	Seismic Load	Earth Load
9.0	0.0	0.0	0.0	10.760	9.0	0.0

DESIGN SUMMARY

	<u>Bottom Level</u>
Vu : Story Shear	26.183 +1.336D+0.50L+2
Mu : Story Moment	202.50 +1.336D+0.50L+2
Nu : Axial	10.373 +1.20D+1.60L
Uplift @ Left End	32.841 +0.7636D+2.50E
Uplift @ Right End	32.841 +0.7636D+2.50E

vu : Applied	47.433 psi
vc * Phi	71.204 psi
vn: max=Phi*10*sqrt(fc)	356.020 psi

Horizontal As Req'd	0.240 in^2
Vertical As Req'd	0.1152 in^2
Bending As Req'd	0.9936 in^2

→ (1) - #9 OR (2) - #7

Concrete Shear Wall

File: examples.ec6
 Software copyright ENERCALC, INC. 1983-2020, Build: 12.20.8.24
 D.S. ENGINEERING PC

Lic. #: KW-06010224

DESCRIPTION: Concrete Shear Wall (South)

Force Summary

Load Combination Wall Level	Values for Wall section			Resultant Ecc (ft)	Overturning Ratio	Uplift (k)	
	Vu (k)	Mu (k)	Pu (k)			Left	Right
+1.40D Wall Level : 1			8.350				
+1.20D+1.60L Wall Level : 1			10.373				
+1.20D+0.50L Wall Level : 1			8.162				
+1.20D+0.50W Wall Level : 1	5.380	48.420	7.157	6.766	0.443	4.687	4.687
+1.20D-0.50W Wall Level : 1	5.380	48.420	7.157	6.766	0.443	4.687	4.687
+1.20D+0.50L+W Wall Level : 1	10.760	96.840	8.162	11.865	0.253	12.583	12.583
+1.20D+0.50L-W Wall Level : 1	10.760	96.840	8.162	11.865	0.253	12.583	12.583
+1.336D+0.50L+2.50E Wall Level : 1	26.183	202.500	8.975	22.562	0.133	30.535	30.535
+1.336D+0.50L-2.50E Wall Level : 1	26.183	202.500	8.975	22.562	0.133	30.535	30.535
+0.90D+W Wall Level : 1	10.760	96.840	5.368	18.042	0.166	14.041	14.041
+0.90D-W Wall Level : 1	10.760	96.840	5.368	18.042	0.166	14.041	14.041
+0.7636D+2.50E Wall Level : 1	26.183	202.500	4.554	44.465	0.067	32.841	32.841
+0.7636D-2.50E Wall Level : 1	26.183	202.500	4.554	44.465	0.067	32.841	32.841

Footing Information

Footing Dimensions

Dist. Left	12.0 ft	f'c	3.0 ksi	Rebar Cover	3.0 in
Wall Length	6 ft	Fy	60.0 ksi	Footing Thickness	18.0 in
Dist. Right	0.0 ft			Width	5.0 ft
Total Ftg Length	18.0 ft				

Max Factored Soil Pressures

@ Left Side of Footing	99999,856 psf
.... governing load comb	+1.336D+0.50L+2.50E
@ Right Side of Footing	99999,856 psf
.... governing load comb	+1.336D+0.50L+2.50E

Max UNfactored Soil Pressures

@ Left Side of Footing	98.784 psf
.... governing load comb	D Only
@ Right Side of Footing	1,031.96 psf
.... governing load comb	+0.60D+0.70E

Footing One-Way Shear Check...

vu @ Left End of Footing	37.682 psi
vu @ Right End of Footing	0.0 psi
vn * phi : Allowable	93.113 psi

Overturning Stability...

Overturning Moment	70.790 k-ft
Resisting Moment	211.626 k-ft
Stability Ratio	2.989 : 1
.... governing load comb	+0.60D+0.70E

@ Left End of Ftg

Overturning Moment	70.790 k-ft
Resisting Moment	211.626 k-ft
Stability Ratio	2.989 : 1
.... governing load comb	+0.60D+0.70E

@ Right End of Ftg

Overturning Moment	70.790 k-ft
Resisting Moment	129.805 k-ft
Stability Ratio	1.834 : 1
.... governing load comb	+0.60D+0.70E

Footing Bending Design...

	@ Left End	@ Right End
Mu	439.741 k-ft	0.0 k-ft
Ru	434.312 psi	0.0 psi
As % Req'd	0.01065 in^2	0.00180 in^2
As Req'd in Footing Width	9.587 in^2	1.944 in^2

~~P=20998~~ (1-14)

$P = 20998^* (F20)$

$20998^* / (6 \times 6) = 583 \text{ psf}$

O.K FOR POINT LOAD

(L): (10) #9
 (S): #5 @ 12" o.c.

1615 psf
 583 psf

SEISMIC:
 @ Grid 'E': Roof : V = 3070 #
 L = 15.33'
 V_{wall} = 3070 lb.
 V_{wall}' = 3070 lb (V_{wall} x R.F.)
 L = 15.33 ft.
 H = 10.50 ft.
 V_{shear} = 200 plf
 T=C= 2174 lb.

WIND:
 @ Grid 'E': Roof : F = 2940 #
 L = 15.33'
 F_{wall} = 2940 lb.
 L = 15.33 ft.
 H = 10.50 ft.
 V_{shear} = 192 plf
 T=C= 2082 lb.

← Mkt 48'
 (3210#)

SEISMIC:
 @ Grid 'E': 2nd Flr : V = 4330 #
 L = 15.33' + 16.5'
 V_{wall} = 2085 lb.
 V_{wall}' = 2085 lb (V_{wall} x R.F.)
 L = 15.33 ft.
 H = 10.50 ft.
 V_{shear} = 136 plf
 T=C= 1476 lb.

WIND:
 @ Grid 'E': 2nd Flr : F = 5745 #
 L = 15.33' + 16.5'
 F_{wall} = 2767 lb.
 L = 15.33 ft.
 H = 10.50 ft.
 V_{shear} = 180 plf
 T=C= 1959 lb.

← 'ABU' (3075#)

SEISMIC:
 @ Grid 'E': 1st Flr : V = 5840 #
 L = 46' (8" Concrete Shearwall)

WIND:
 @ Grid 'E': 1st Flr : F = 7670 #
 L = 46' (8" Concrete Shearwall)

Q = 7670 / 46 = 167 #/ft
 V = 5840 (6.5/5) = 790 #
 = 8" CONC WALL w/ #5 @ 16" o.c. (Horizontal)

SEISMIC:
 @ Grid 'W': Roof : V = 3070 #
 L = 3.46' + 3.56'

$V_{wall} = 1513$ lb.
 $V_{wall} = 1513$ lb ($V_{wall} \times R.F.$)
 L = 3.46 ft.
 H = 10.50 ft.
 $V_{shear} = 437$ plf <W2
 T=C= 5367 lb.

T10# x 2 x 3.46 / 0.4
 = 507# / > 437# ✓
 O.K. ✓

WIND:
 @ Grid 'W': Roof : F = 2940 #
 L = 3.46' + 3.56'

$F_{wall} = 1449$ lb.
 L = 3.46 ft.
 H = 10.50 ft.
 $V_{shear} = 419$ plf <W2
 T=C= 5140 lb.
 $F_{wall} = 1491$ lb.
 L = 3.56 ft.
 H = 10.50 ft.
 $V_{shear} = 419$ plf <W2
 T=C= 5116 lb.

'MKT60'
 (5240#) CLOSE ENOUGH @ SEFS

SEISMIC:
 @ Grid 'W': 2nd Flr : V = 4330 #
 L = 5.25' + 5.25' + 6.5'

$V_{wall} = 1337$ lb.
 $V_{wall} = 1337$ lb ($V_{wall} \times R.F.$)
 L = 5.25 ft.
 H = 10.50 ft.
 $V_{shear} = 255$ plf <TFP
 T=C= 2955 lb.

O.K. ✓

WIND:
 @ Grid 'W': 2nd Flr : F = 5745 #
 L = 5.25' + 5.25' + 6.5'

$F_{wall} = 1774$ lb.
 L = 5.25 ft.
 H = 10.50 ft.
 $V_{shear} = 338$ plf <TFP
 T=C= 3921 lb.
 $F_{wall} = 2197$ lb.
 L = 6.50 ft.
 H = 10.50 ft.
 $V_{shear} = 338$ plf <TFP
 T=C= 3845 lb.

'HBUK'

SEISMIC:
 @ Grid 'W': 1st Flr : V = 5840 #
 L = 32' (8" Concrete Shearwall)

V = 5840# (6.5/5)
 = 7590#

WIND:
 @ Grid 'W': 1st Flr : F = 7670 #
 L = 32' (8" Concrete Shearwall)

7670# / 32' = 240# /

16" CONC WALL w/ #5 @ 16" O.C (HORIZ)

22007 - Strand Seismic

Materials	
	Loose FILL
	Medium-Dense Silty SAND
	Dense GLACIAL TILL

Name: Loose FILL
 Unit Weight: 120 pcf
 Cohesion: 0 psf
 Phi: 30°

Name: Medium-Dense Silty SAND
 Unit Weight: 125 pcf
 Cohesion: 0 psf
 Phi: 34°

Name: Dense GLACIAL TILL
 Unit Weight: 140 pcf
 Cohesion: 100 psf
 Phi: 40°

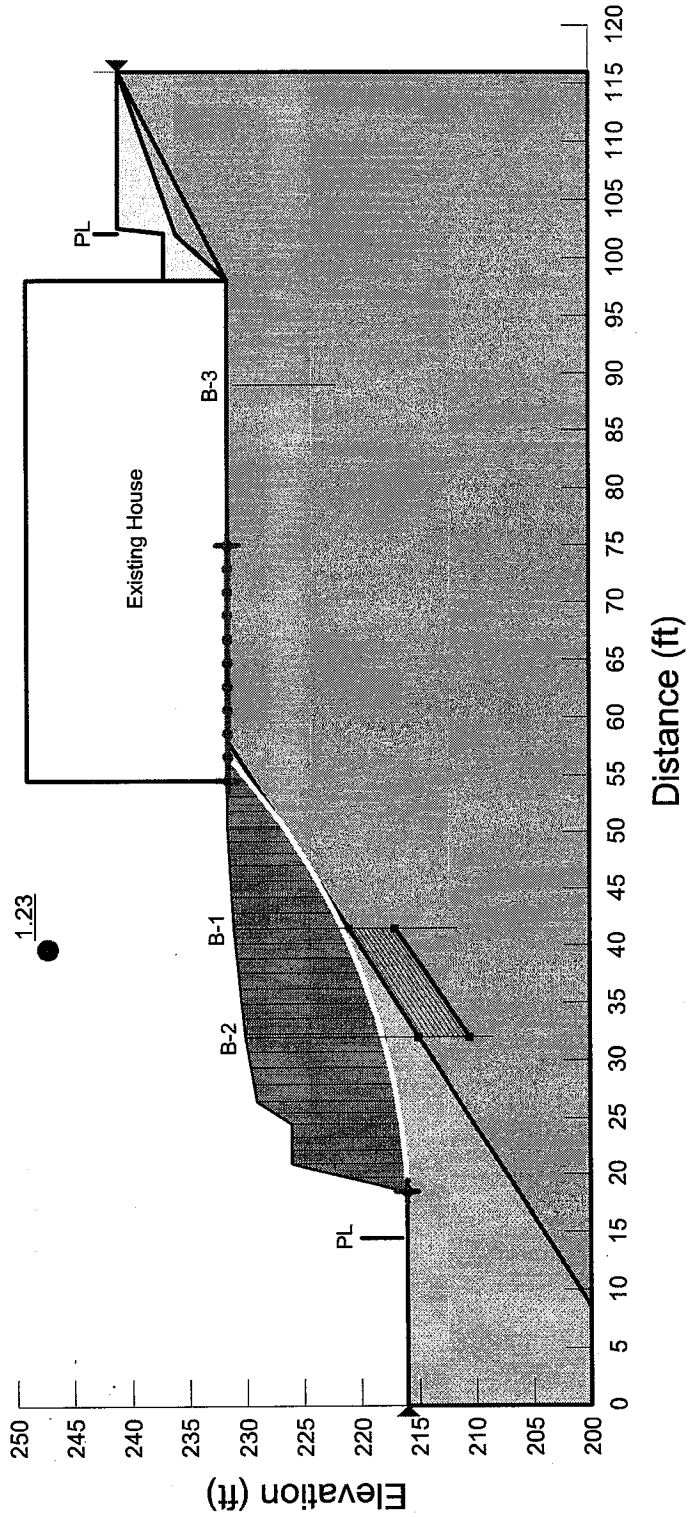

SEISMIC CONSIDERATIONS

In accordance with the International Building Code (IBC), the site class within 100 feet of the ground surface is best represented by Site Class Type D (Stiff Soil). As noted in the USGS website, the mapped spectral acceleration value for a 0.2 second (S_s) and 1.0 second period (S_1) equals 1.41g and 0.49g, respectively.

The IBC and ASCE 7 require that the potential for liquefaction (soil strength loss) during an earthquake be evaluated for the peak ground acceleration of the Maximum Considered Earthquake (MCE), which has a probability of occurring once in 2,475 years (2 percent probability of occurring in a 50-year period). The MCE peak ground acceleration adjusted for site class effects (F_{PGA}) equals 0.67g. The soils beneath the site are not susceptible to seismic liquefaction under the ground motions of the MCE because of their dense nature and the absence of a defined near-surface water table.

Sections 1803.5 of the IBC and 11.8 of ASCE 7 require that other seismic-related geotechnical design parameters (seismic surcharge for retaining wall design and slope stability) include the potential effects of the Design Earthquake. The peak ground acceleration for the Design Earthquake is defined in Section 11.2 of ASCE 7 as two-thirds (2/3) of the MCE peak ground acceleration, or 0.44g.

CONVENTIONAL FOUNDATIONS

The proposed residence can be supported on conventional continuous and spread footings bearing on undisturbed, dense to very dense glacial till. We recommend that continuous and individual spread footings have minimum widths of 12 and 16 inches, respectively. Exterior footings should also be bottomed at least 18 inches below the lowest adjacent finish ground surface for protection against frost and erosion. The local building codes should be reviewed to determine if different footing widths or embedment depths are required. Footing subgrades must be cleaned of loose or disturbed soil prior to pouring concrete. Depending upon site and equipment constraints, this may require removing the disturbed soil by hand.

Thickened slabs are sometimes included in the design to support interior walls. It is important to remember that thickened slab areas support building loads, just like conventional footings do. For this reason, the subgrade below thickened slabs must be prepared in the same way as for conventional footings. All unsuitable soils have to be removed and any structural fill compacted in accordance with the recommendations of this report. We recommend against the use of thickened slabs for most projects, particularly single-family residential, as it is difficult to ensure that the subgrades have been appropriately prepared. Also, the compacted slab fill has to be protected from disturbance by the earthwork, foundation, and utility contractors.

An allowable bearing pressure of 3,000 pounds per square foot (psf) is appropriate for footings supported on dense to very dense glacial till. A one-third increase in this design bearing pressure may be used when considering short-term wind or seismic loads. For the above design criteria, it is anticipated that the total post-construction settlement of footings founded on competent native soil, will be about one inch, with differential settlements on the order of one half-inch in a distance of 50 feet along a continuous footing with a uniform load.

Lateral loads due to wind or seismic forces may be resisted by friction between the foundation and the bearing soil, or by passive earth pressure acting on the vertical, embedded portions of the

foundation. For the latter condition, the foundation must be either poured directly against relatively level, undisturbed soil or be surrounded by level, well-compacted fill. We recommend using the following ultimate values for the foundation's resistance to lateral loading:

PARAMETER	ULTIMATE VALUE
Coefficient of Friction	0.50
Passive Earth Pressure	300 pcf

Where: pcf is Pounds per Cubic Foot, and Passive Earth Pressure is computed using the Equivalent Fluid Density.

If the ground in front of a foundation is loose or sloping, the passive earth pressure given above will not be appropriate. The above ultimate values for passive earth pressure and coefficient of friction do not include a safety factor.

FOUNDATION AND RETAINING WALLS

Retaining walls backfilled on only one side should be designed to resist the lateral earth pressures imposed by the soil they retain. The following recommended parameters are for walls that restrain level backfill:

PARAMETER	VALUE
Active Earth Pressure *	
- Level Backfill	35 pcf
- Eastern Foundation Wall With Adjacent Upslope Walls	55 pcf
Passive Earth Pressure	300 pcf
Coefficient of Friction	0.50
Soil Unit Weight	130 pcf

Where: pcf is Pounds per Cubic Foot, and Active and Passive Earth Pressures are computed using the Equivalent Fluid Pressures.

* For a restrained wall that cannot deflect at least 0.002 times its height, a uniform lateral pressure equal to 10 psf times the height of the wall should be added to the above active equivalent fluid pressure. This applies only to walls with level backfill.

The design values given above do not include the effects of any hydrostatic pressures behind the walls and assume that no surcharges, such as those caused by slopes, vehicles, or adjacent foundations will be exerted on the walls. If these conditions exist, those pressures should be added to the above lateral soil pressures. Where sloping backfill is desired behind the walls, we will need to be given the wall dimensions and the slope of the backfill in order to provide the appropriate design earth pressures. The surcharge due to traffic loads behind a wall can typically be accounted for by adding a uniform pressure equal to 2 feet multiplied by the above active fluid density. Heavy construction equipment should not be operated behind retaining and foundation walls within a distance equal to the height of a wall, unless the walls are designed for the additional lateral pressures resulting from the equipment.

The values given above are to be used to design only permanent foundation and retaining walls that are to be backfilled, such as conventional walls constructed of reinforced concrete or masonry. It is not appropriate to use the above earth pressures and soil unit weight to back-calculate soil strength parameters for design of other types of retaining walls, such as soldier pile, reinforced earth, modular or soil nail walls. We can assist with design of these types of walls, if desired.

The passive pressure given is appropriate only for a shear key poured directly against undisturbed native soil, or for the depth of level, well-compacted fill placed in front of a retaining or foundation wall. The values for friction and passive resistance are ultimate values and do not include a safety factor. Restrained wall soil parameters should be utilized the wall and reinforcing design for a distance of 1.5 times the wall height from corners or bends in the walls, or from other points of restraint. This is intended to reduce the amount of cracking that can occur where a wall is restrained by a corner.

Wall Pressures Due to Seismic Forces

Per IBC Section 1803.5.12, a seismic surcharge load need only be considered in the design of walls over 6 feet in height. A seismic surcharge load would be imposed by adding a uniform lateral pressure to the above-recommended active pressure. The recommended seismic surcharge pressure for this project is $9H$ pounds per square foot (psf), where H is the design retention height of the wall. Using this increased pressure, the safety factor against sliding and overturning can be reduced to 1.2 for the seismic analysis.

Retaining Wall Backfill and Waterproofing

Backfill placed behind retaining or foundation walls should be coarse, free-draining structural fill containing no organics. This backfill should contain no more than 5 percent silt or clay particles and have no gravel greater than 4 inches in diameter. The percentage of particles passing the No. 4 sieve should be between 25 and 70 percent. Drainage composite similar to Miradrain 6000 should be placed against the backfilled retaining walls. The drainage composites should be hydraulically connected to the foundation drain system. Free-draining backfill should be used for the entire width of the backfill where seepage is encountered. For increased protection, drainage composites should be placed along cut slope faces, and the walls should be backfilled entirely with free-draining soil. The later section entitled ***Drainage Considerations*** should also be reviewed for recommendations related to subsurface drainage behind foundation and retaining walls.

The purpose of these backfill requirements is to ensure that the design criteria for a retaining wall are not exceeded because of a build-up of hydrostatic pressure behind the wall. Also, subsurface drainage systems are not intended to handle large volumes of water from surface runoff. The top 12 to 18 inches of the backfill should consist of a compacted, relatively impermeable soil or topsoil, or the surface should be paved. The ground surface must also slope away from backfilled walls at one to 2 percent to reduce the potential for surface water to percolate into the backfill.

Water percolating through pervious surfaces (pavers, gravel, permeable pavement, etc.) must also be prevented from flowing toward walls or into the backfill zone. Foundation drainage and waterproofing systems are not intended to handle large volumes of infiltrated water. The compacted subgrade below pervious surfaces and any associated drainage layer should therefore be sloped away. Alternatively, a membrane and subsurface collection system could be provided below a pervious surface.